



INSTALLATION MANUAL

Energy Storage System

Please read this manual carefully before operating and retain it for future reference.

Model

LG ESS Home 8 (RBA008K0A00)

Home 8 (RA768K16A11)

Smart Energy Box (REA200AP0)



* M F L 7 1 8 9 3 1 0 1 *

Rev. B 08/09/2022

<http://www.lg.com/us/ess>

Copyright © 2022 LGEUS All Rights Reserved.

Due to our policy of continuous product innovation, some specifications may change without notice.
©LG Electronics U.S.A., Inc., Englewood Cliffs, NJ. All rights reserved. "LG" is a registered trademark of LG Corp.

PROPRIETARY DATA NOTICE

This document, as well as all reports, illustrations, data, information, and other materials, are the property of LG Electronics U.S.A., Inc., and are disclosed by LG Electronics U.S.A., Inc. only in confidence.

Do not throw away, destroy, or lose this manual.

Please read carefully and store in a safe place for future reference.
Content familiarity is required for proper installation.

The instructions included in this manual must be followed to prevent product malfunction, property damage, injury, or death to the user or other people. Incorrect operation due to ignoring any instructions will cause harm or damage. The level of seriousness is described by the summary list of Important Safety Instruction.

For continual product development, LG Electronics U.S.A., Inc. reserves the right to change specifications without notice.
© LG Electronics U.S.A., Inc.

Important Safety Instructions

IMPORTANT: This product should not be used for any purpose other than the purpose described in this installation manual.

SAVE THESE INSTRUCTIONS : This manual contains important instructions for LG ESS Home 8 (RBA008K0A00) consisting of PCS (RA768K00A10), Battery Module (BPLG004HBG1), and SE Box (REA200AP0) that shall be followed during the installation and maintenance of Energy Storage System (ESS).

The LG ESS Home 8 has been designed and tested to meet applicable North America and International safety standards. As with any electrical and electronic devices, safety precautions must be observed during the installation and operation of the LG ESS Home 8 to reduce the risk of personal injury and to ensure safe installation.

Installation, commissioning, service, and maintenance of the LG ESS Home 8 must be performed only by trained service providers who are licensed and/or who meet the applicable state, local jurisdiction regulations, follow the instructions in this manual, and using personal protective equipment (PPE). All transport or handling of the LG ESS Home 8 product must be done in accordance with local safety standards.

Before starting the installation or commissioning of the LG ESS Home 8, read through the entire manual and take note of all precautions.

All U.S. and Canada electrical installations must be done in accordance with local codes and the National Electric Code (NEC) ANSI/NFPA 70 or the Canadian Electrical Code CSA C22.1.

In Canada, the installation and wiring methods used must comply with parts I and II of the Canadian Electric Code, and local AHJ inspector requirements. When required by Part 1 of the Canadian Electrical Code, system grounding is the responsibility of the installer.

LG ESS system is not intended for use as a primary or backup power source for life-support systems, other medical equipment, or any other use where product failure could lead to injury to persons or loss of life or catastrophic property damage. LG disclaims any and all liability arising out of any such use of the system. Further, LG reserves the right to refuse to service any system used for these purposes and disclaims any and all liability arising out of LG's service or refusal to service systems in such circumstances.



DANGER

Indicates a hazardous situation that will result in death or serious injury if the instruction is not followed.

- Do not open the door. There are no user serviceable parts inside. Service may be performed only by trained service provider.
- Risk of electric shock from energy stored in capacitor. Do not remove the door until 10 minutes after disconnecting all sources when service needed.
- Electric shock hazard. Do not touch uninsulated wires when the product cover is removed.
- Do not disconnect, disassemble, or repair to avoid injuries, electric shock or burns.
- There is a high possibility of electric shock or serious burns due to the high voltages in the ESS.
- The AC cables are high voltage. Risk of death or serious injury due to electric shock.
- This product poses potential danger such as death or serious injury by fire, high voltages, or explosion if appropriate precautions are not read, fully understood, and followed.
- Do not place or install flammable or potentially explosive objects near the product or in explosive atmospheres.
- Do not charge or discharge arbitrarily. It may lead to fault, electric shock, or burns.
- Do not damage the unit in any manner, such as by dropping, deforming, impacting, cutting, or spearing with a sharp object. It may cause electrolyte leakage or fire.
- Breakdown of the unit may cause electrolyte leakage or flammable gas generation.
- If electrolytes leak, avoid contact with eyes, skin, or clothes. In event of accidental contact, flush with water and seek medical help immediately.
- Do not place near open flame or incinerate. It may lead to fire or explosion.
- Keep the unit away from moisture or liquid. Do not touch or use the product if liquids have been spilled on it.
- Keep out of reach of children or animals.
- Electrical installations must be done in accordance with local standards, national electrical safety standards, and the manufacturer's instructions.
- The battery system is a bidirectional source of voltage. The battery circuit breaker and inverter must both be off before working in the wiring box.
- Disconnect each circuit individually before servicing. Both AC and DC voltage sources are terminated inside this equipment.
- Do not dispose of batteries in a fire. The batteries may explode.
- Do not open or assemble while product is working.



WARNING

Indicates a potentially dangerous situation. Death or serious injury may result if appropriate precautions are not taken.

- A potentially hazardous circumstance such as excessive heat or electrolyte mist may occur due to improper operating conditions, damage, misuse and/or abuse.
- The contents included in this box are the ESS and its accessories. The total weight is very heavy. Serious injury may occur due to the weight of the package containing the ESS and accessories. Therefore, special care must be taken in handling. Make sure to use the handle lift to deliver and install the package.
- Do not open or damage batteries. Released electrolyte is harmful to the skin and eyes. It may be toxic.
- Do not place heavy objects on this product. It may cause deformation or fracture.
- Do not place any kind of objects on top of the product during operation.
- All work on the ESS must be carried out by trained service providers only.
- Electrical installations must be done in accordance with the local and national electrical safety standards.
- Wear rubber gloves and protective clothing (including protective glasses and boots) when working on the ESS.
- To reduce the risk of fire, do not connect to an AC load center (circuit breaker panel) with multiwire branch circuits connected.



CAUTION

Indicates a situation where damage or injury may occur. If it is not avoided, minor injury and/or damage to property may result.

- Before testing electrical parts inside the system, there is a minimum of a 10 minute standby period to completely discharge the system.
- Do not use any damaged, cracked, or frayed electrical cables or connectors. Protect the electrical cables from physical or mechanical abuse, such as being twisted, kinked, pinched, closed in a door, or stepped on. Periodically examine the electrical cables of your product. If the appearance indicates damage or deterioration, discontinue use of this product and have the cables replaced with an exact replacement part by a qualified personnel.
- Ensure that you connect the earth ground wire to prevent possible electric shock. Do not try to ground the product by connecting it to telephone wires, lightning rods, or gas pipes.
- Do not put the product or components in water or liquid.
- Make sure that there are no water sources, such as faucets or sprinklers, near the installation site.
- Do not block any ventilation openings. Ensure reliable operation of the product and protect it from overheating. Do not block any openings by placing objects on this product.
- The metal enclosure may heat to a high temperature during operation.
- The product must be disposed of according to local regulations.
- If the ESS is not operated for a long time, the battery may be overdischarged.
- Do not step on the product or the product package. The product may be damaged.
- Batteries may present a risk of electrical shock and high short-circuit current. The following precautions should be observed when working on the ESS system include:
 - a) Remove watches, rings, and other metal objects.
 - b) Use tools with insulated handles.
 - c) Wear rubber gloves, boots, and glasses.
 - d) Do not lay tools or metal parts on top of the system.
- In the event of fault, the system must not be restarted. Product maintenance and repairs must be performed by trained service providers.
- If a system fault occurs immediately after starting the system, check the error code on the Smart Energy Box (SE Box) display and follow the solution described in the manual.

INFO Indicates a risk of possible damage to the product.

- This product is intended for residential use only and is not intended for use in industrial Purposes.
- The System consists of Home 8 and SE Box. They must be installed together and it will not work when installing unauthorized components to the system.
- The unit is designed to feed power to the public grid only. Do not connect the unit to a generator as connecting the power to external devices could result in serious damage to the equipment.
- LG ESS Home 8 performs best when it is connected to the internet and registered through the ThinQ service, so that the firmware may be remotely updated periodically.
- For the latest ESS documents, visit:
 - Warranty : <https://www.lg.com/us/ess/warranty>
 - Installation Manual : <https://www.lg.com/us/ess/Installationmanual>
 - User Manual : <https://www.lg.com/us/ess/usermanual>
 - Quick Installation Guide : <https://www.lg.com/us/ess/quickstart>
- If the S/W version is not up to date during installation, update the S/W using a FAT32 formatted USB storage device. When the SE Box is connected to Ethernet through a LAN cable after normal operation, it is automatically updated to the latest S/W version.
- Handling of batteries should be performed or supervised by a trained service provider.
- The battery does not discharge when the load is under a certain level.
- To prevent network problems, check the "Network Settings" before installation.
- Do not store or place any objects on top of or against the unit. It may cause serious malfunction or other problems.
- Never use any solvents, abrasives, or corrosive materials to clean this unit.
- Under backup operation, whether the battery SoC is higher than 90% or the ESS needs to reduce the charging power, the ESS may reduce the solar power generation.
- If the battery SoC is too low during backup operation during a power outage, the system operates as follows.
 - Even though the PV system is equipped, the system will not supply power to the home load. However, the system can charge the battery from the PV system first and then supply power to the home again if the battery SoC is sufficiently charged.
 - If the PV system is not equipped, the system cannot supply power to the home load and the system will go into sleep mode.

First Aid Measures

The Product includes internal fault mechanisms designed to prevent failures and subsequent risk hazards. However, LG Electronics cannot guarantee the safe performance of the Product if it is ever exposed to abuse, damage, or negligence.

If a user happens to be exposed to the internal materials of the battery cell due to damage on the outer casing, the following actions are recommended.

- In case of inhalation: Leave the contaminated area immediately and seek medical attention.
- In case of contact with eyes: Rinse eyes with running water for 15 minutes and seek medical attention.
- In case of contact with skin: Wash the contacted area with soap thoroughly and seek medical attention.
- In case of ingestion: Induce vomiting and seek medical attention.

Fire Fighting Measures

Suitable extinguishing media

Use metal fire extinguishing powder or dry sand if only a few cells are involved. In case of a large fire, use a large amount of water to extinguish.

Special hazards arising from the chemical

May form hydrofluoric acid if electrolyte comes into contact with water.

In case of fire, the formation of the following flue gases cannot be excluded: Hydrogen fluoride (HF), Carbon monoxide, and carbon dioxide.

Protective equipment and precautions for firefighters

If batteries are charging, shut off power.

Wear a self-contained breathing apparatus and protective suit.



WARNING

If heated above 130 °C (266 °F), there is a risk of fire, explosion, physical injury, or death.

Effective way to deal with accidents

- On land : Do not touch the damaged battery and call your local fire department or service engineer.
- In water : Stay out of the water and do not touch anything if any part of the ESS or wiring is submerged.
- Do not use the submerged battery again. Contact your service engineer for assistance.

Table of Contents

Getting Started

Important Safety Instructions	3
First Aid Measures	8
Product Features	11
Unpacking	16
Unpacking the SE Box	16
Unpacking the Home 8	17
Part Names	22
Front and Rear (Home 8)	22
Connection Parts (Home 8)	23
LED Indications (Home 8)	24
Front and Rear (SE Box)	25
Connection Parts (SE Box)	26

Installation

Plan the Installation	27
Installation Location	28
Distance Between Components	30
Minimum Clearance	31
Floor Standing Wall Support	33
Mounting the Home 8	33
Mounting the SE Box	38
Connections	41
Whole Home Backup (Service Equipment)	41
Service Equipment Preparation (If Required)	42
Wiring Connection between the SE Box and Home 8	45
Grid and Load Connections	53
Connect to PV Inverter	57
Internet Connection	61
External Shutdown Switch Installation (If Required)	62
Backup Load Connection	65
Backup Testing Guidelines	66
Installation Completion	68
Wiring Reference	72

Table of Contents

Settings

Installer Setup Wizard	78
About the HOME Screen	87
Installer and User Settings	89
General Settings	90
PCS Settings	97
EnerVu Settings (Installer Only)	107
Creating a New Account (Administrator)	107
Adding a New Installer	108
Registering The System (Web Browser)	110
Incomplete Registration Status	112
Using LG ThinQ® Applications (For User)	113
Installing LG ThinQ®	113
Using LG ThinQ®	114

Troubleshooting

Error Codes and Messages	116
PCS Error Codes	116
SE Box Error Code	118
Battery Error Code	119

Appendix

Black Start	123
Maintenance	124
Cleaning the Product	124
Inspecting Regularly	124
Shutting Down the System	124
Disposing the product	125
Compliance Information	126
Specifications	128
Compatible Eaton Parts	133
Multiple Home 8 Units or PV Inverters Connection	135
Usage of External CTs	141
Multiple Connection ID Setup Method	143
Communication Connections In Multiple Installation	144
Battery Pack Disassembly Guide	145
Wiring Diagram	149

Product Features

This product is an All In One Energy Storage System (ESS) designed with a grid-connected inverter and integrated battery. Also, it is possible to supply power in case of a power outage through the Smart Energy Box (SE Box). The built-in PMS (Power Management System) in SE Box provides the optimal charging/discharging operation by monitoring the home power usage status, PV power generation, grid power status, consumer electricity plan, and weather forecast. ATS function can be enabled for backup power in the built-in PMS, which can provide automatic seamless transfer switching.

(In order to use all functions smoothly, users must connect this product to the Internet and subscribe to the LG ThinQ® service.)

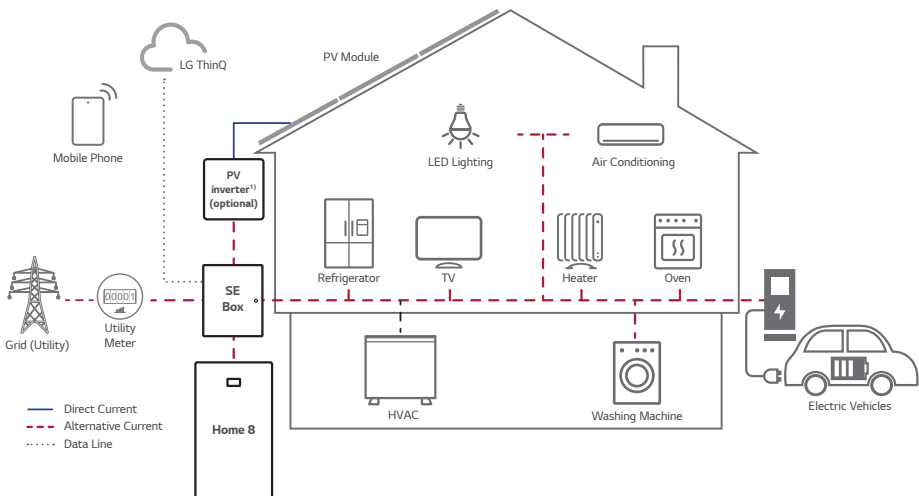

1) PV inverter is NOT PROVIDED by LG Electronics.

- **All In One ESS**

LG ESS Home 8 is a product designed to integrate a grid-connected inverter and battery in one enclosure. This product is an AC-Coupled type and is directly connected to the household power grid.

- **Single-phase Three-wire Connection (Split Phase Only)**

This product is for use exclusively for single-phase three-wire electric power grids used in the home.

- **Smart Management**

The built-in Smart PMS analyses PV generation, load consumption, electricity rate, and weather information. It also monitors the main system & battery conditions to maintain a stable condition. Internet connection and LG ThinQ® connection required.

- **App & Web-Monitoring Service**

The home owner and installer can monitor their ESS with various devices such as a PC, tablet, or smart phone.

- **Backup Mode**

During a power outage, this system supplies emergency power to the household loads. When the grid experienced an outage, SE Box can automatically switch the power source from the utility grid to Home 8. For these functions, "Backup" should be enabled in the system.

- **System Scalability**

Up to 4 Home 8 units can be connected to one SE Box. (The required number of Home 8 may vary depending on the electric service capacity, the load consumption characteristic, and the preferred operation of the home. Please contact an authorized dealer or the seller for more details.)

System configuration

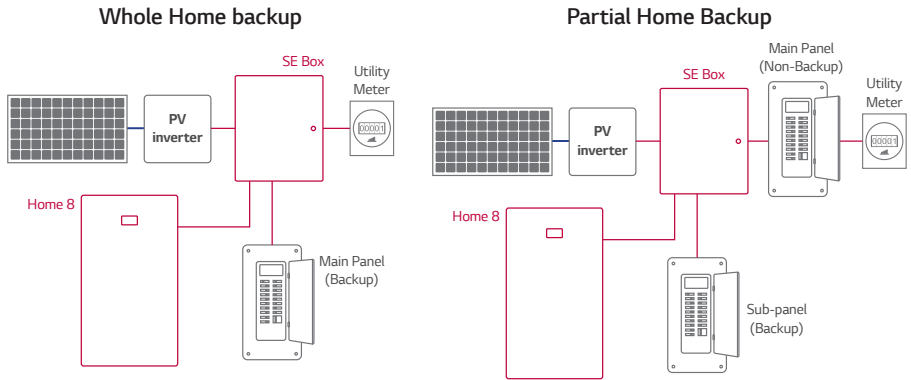

Product Specifications









All specifications and descriptions contained in this document are verified to be accurate at the time of printing. However, since continuous improvement is a goal at LGEUS, we reserve the right to make product modifications at any time.







The images provided in this document are for demonstration purposes only. Depending on product version and market region, details may appear slightly different.

©2022 LGEUS Inc. All rights reserved.

Due to our policy of continuous product innovation, some specifications may change without notification. ©LG Electronics U.S.A., Inc., Englewood Cliffs, NJ. All rights reserved. "LG" is a registered trademark of LG Corp.

Symbol Used on Labels

Symbol	Description
	UL approval Listing Mark
	UL approval Recognized
	Risk of Electric Shock
	This product should not be disposed of with other household waste. Disposal regulations of the country should be observed.
	Identifies any terminal intended for connection to an external conductor for protection against electrical shock in case of a fault or the terminal of a protective earth (ground) electrode.
	Read the instruction manual/booklet before starting work or before operating equipment or machinery.
	Caution, risk of danger
	Caution, hot surface
	Caution, risk of electric shock, energy storage timed discharge
	Caution, risk of electric shock
	No open flame, open ignition source, or smoking
	Wear protective glasses when working on the battery unit.
	Install this product out of reach of children.
	Take care when handling corrosive substances.
	Take care when handling explosive materials.
	Serious injury may occur due to the heavy weight of the product.

Symbol	Description
	Observe precautions for handling electrostatic discharge sensitive devices.
	Disconnect the machine or equipment before carrying out maintenance or repair.
	Take care to avoid causing a fire by igniting flammable material.
	Ensure adequate ventilation of the charging area and take care to avoid coming in contact with acid.
	In case of contact with acid material, immediately flush the area with plenty of water. Get medical attention immediately. Wash contaminated clothing before reuse with sufficient water.
	Fire extinguishers must be used to put out flames.
	Ensure the conductive terminals are matched to their corresponding counterparts.

Abbreviations in this Manual

Abbreviation	Designation	Explanation
ESS	Energy Storage System	Inverter system that stores energy in a battery and uses it.
Home 8	All In One unit	Battery integrated PCS
SE Box	Smart Energy Box	Micro-grid interface device that consist of an ATS (automatic transfer switch), energy meter, and Smart Controller.
PCS	Power Conditioning System	A device intended to convert AC/DC electricity to charge and discharge the battery.
PMS	Power Management System	A device to control the whole system, including the power management algorithm, and to communicate with the cloud server.
ATS	Automatic Transfer Switch	A device to separate the home micro grid from the utility grid.
PV	Photovoltaic	A solar panel system that converts solar energy into direct current electricity.
SoC	State of Charge	The current charge level of a rechargeable battery relative to its capacity.

Abbreviation	Designation	Explanation
BCU	Battery Control Unit	An electronic system that control a rechargeable battery system for securing battery safety.
DC	Direct Current	-
AC	Alternating Current	-
DHCP	Dynamic Host Configuration Protocol	Standardized network protocol used on Internet Protocol (IP) networks for automatic distributing network configuration parameters, such as IP addresses for interfaces and services.
LAN	Local Area Network	A network that interconnects computers within a limited area.
IP	Internet Protocol	A set of rules for sending data across a network.

Unpacking

Unpacking the SE Box

Unpack the SE Box from its packaging.

! WARNING

Take care when moving or installing the SE Box. It may cause injury due to the weight. At least 2 people are needed for safe installation and moving.

1

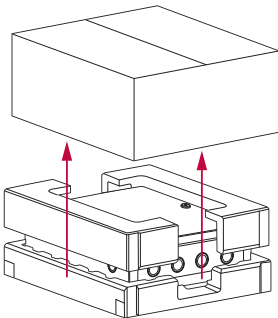

Remove the package banding and open the box.

2

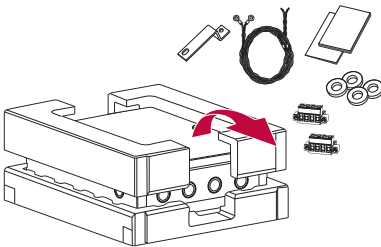

Take out all the accessories and components.

3

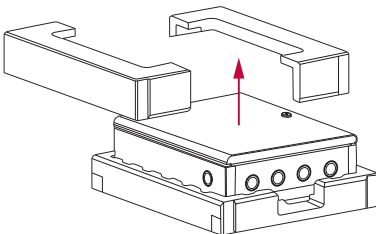

Pull out the SE Box from the package.

Unpacking the Home 8

Unpack the Home 8 from its packaging.

WARNING

- When working on the Home 8, at least 3 people are needed for safe installation and moving.
- Make sure the lift does not move when standing the product on the lift.
- When moving the product using a lift, secure the product using a belt, etc.

INFO

Be careful not to damage Home 8 when standing the product on the hand lift. The cut-out part at the bottom of the box can be used to prevent scratches by inserting it between the product and the hand lift.

1

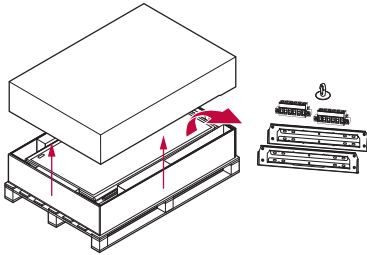

Remove the package banding and open the box. Take out all the accessories and components.

2

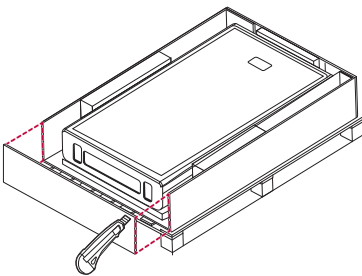

Cut the bottom of the box so that the hand lift can fit through the bottom.

WARNING

Be careful to avoid injury when cutting the bottom of the package.

 **INFO**

If the installation location has excessive presence of insects, block the vent hole with the Vent Plug, if needed.

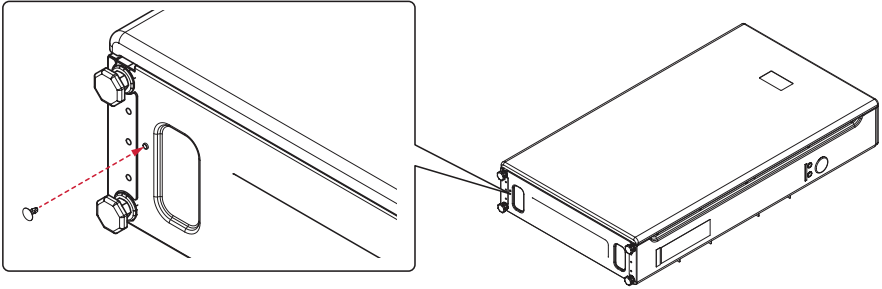

3

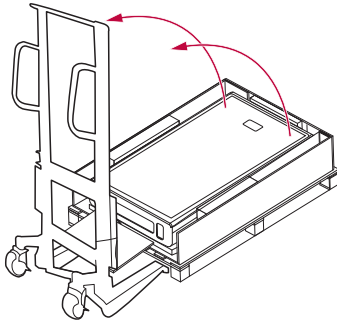

Put the hand lift into the bottom of the package and stand the Home 8 upright on the hand lift.

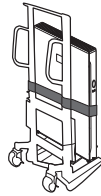

Home 8 Contents

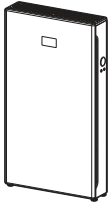

Home 8 (1EA)

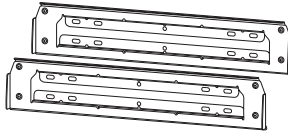

Wall bracket (2EA)

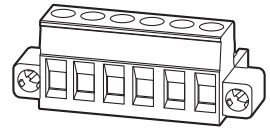

Communication terminal block (2EA)

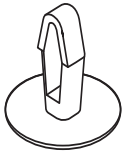

Vent plug

SE Box Contents

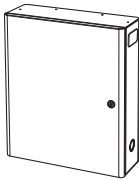

SE Box

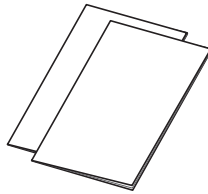

Quick Installation Guide & Mount Hole Guide

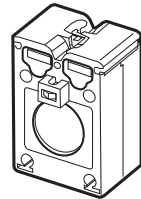

200A CT for PV



CT harness

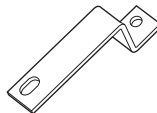

N-GND bonding busbar



O rings (4EA)



CT terminal block (2EA)

Required Tools



Insulated gloves
(Class 0: 1,000AC
/1500 DC-Red
recommended)



Safety glasses



Protective footwear

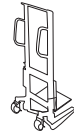

Lift equipment
(190 kg up to 1.5 m)



Drill and drill bit

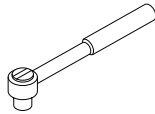

Torque wrench with hex
socket
M5 (1/4 inch), M6 (3/8
inch), M8 (5/16 inch)

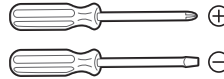

Screw driver
Phillips (5 mm)
Flat head (6, 5, 4, 2
mm)

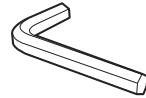

Hex wrench
6 mm (1/4 inch),
8 mm (5/16 inch)

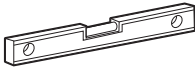

Inclinometer

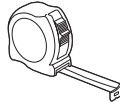

Tape measure



Writing utensil

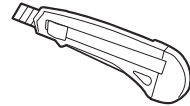

Cutter

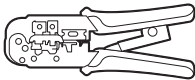

RJ 45 crimping tool



Wire strippers (A)

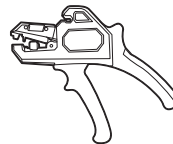

Wire strippers (B)

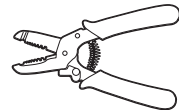

Wire strippers (C)

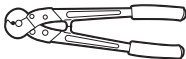

Wire cutter (A)

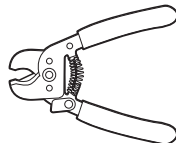

Wire cutter (B)



Spanner
17 mm (21/32 inch)



Ring terminal crimping
tool (optional)

WARNING

The Home 8 and SE Box are heavy. Wear appropriate personal protective equipment (such as gloves and protective footwear) when handling these units.

Required Materials and Components

- SE Box mounting hardware and a Home 8 wall bracket
- Conduit or raceway (depending on local electrical requirements)
- Conduit adapters.
 - necessary for cable entry into Home 8 wiring compartment and the SE Box.
 - For conduit adapters, use only UL Listed 3R type raintight or wet location hubs for entry into the enclosure.
- Communication Cable (SE Box-Home 8)
 - Minimum 300V rated 6-conductor Shielded Twisted Pair copper (Cu) cable (or Double-insulated Shielded Twisted Pair copper (Cu) cable)
 - CAT5 STP or CAT6 STP 24-16 AWG would be used (UL-approved Required)
 - Two 6-position terminal blocks for this communication cable are included in the Home 8 package.
- Communication Cable (RS485, STOP, AUX in the SE Box)
 - Minimum 300V rated unshielded twisted pair cable.
 - CAT5 UTP or better
- Ethernet Cable (SE Box)
 - Minimum 300V rated CAT5 UTP or better (If needed, RJ45 connectors should be prepared)
- Power and Grounding Cable for Home 8 connection
 - Minimum 600 V rated copper (Cu) cable rated at 90 °C (194 °F)
 - 6-4 AWG (BLACK/WHITE/RED)
 - 8-6 AWG (GREEN)
 - Follow NEC and local codes
- Power and Grounding Cable for SE Box connection
 - Minimum 600 V rated copper (Cu) or aluminum (Al) cable rated at 90 °C (194 °F) or better.
 - 6 AWG - 250 kcmil (BLACK / WHITE / RED)
 - 14 AWG - 2/0 AWG (BLACK / WHITE / RED / GREEN or Bare)
 - Follow all NEC and local codes
- Breakers, Lugs, and Accessories
 - Follow all NEC and the local codes for breaker sizing. Please refer to "Compatible Eaton Parts" .
 - Main Breaker : CSR2100, CSR2125N, CSR2150N, CSR2175N, CSR2200N, BW2100, BW2125, BW215N, BW2175 or BW2200 from Eaton
 - Branch Breaker for Home 8 and PV inverter connection : Eaton BR series should be used for the internal panelboard.
 - Hold Down Kit for fixing BR series circuit breaker : BRHDK125
 - Sub feed lug for the internal panelboard : Eaton BRS225 / BRPSF225
- (If required) External CT and its connector
 - If you would like to know in which situations an external CT is required, please refer to "Usage of External CTs". These CTs are available from LGEUS and the additional cables are required to connect external CTs to a SE Box. The installer should prepare CTs and related components before the installation and make them on site.
 - CT : CTD-1X.200.1A.XXX
 - Cable : 600V UL 1015 AWG 18 recommended
 - Ring terminal lugs : stud size - 1/4 inch, wire range - 18AWG min.

Part Names

Front and Rear (Home 8)

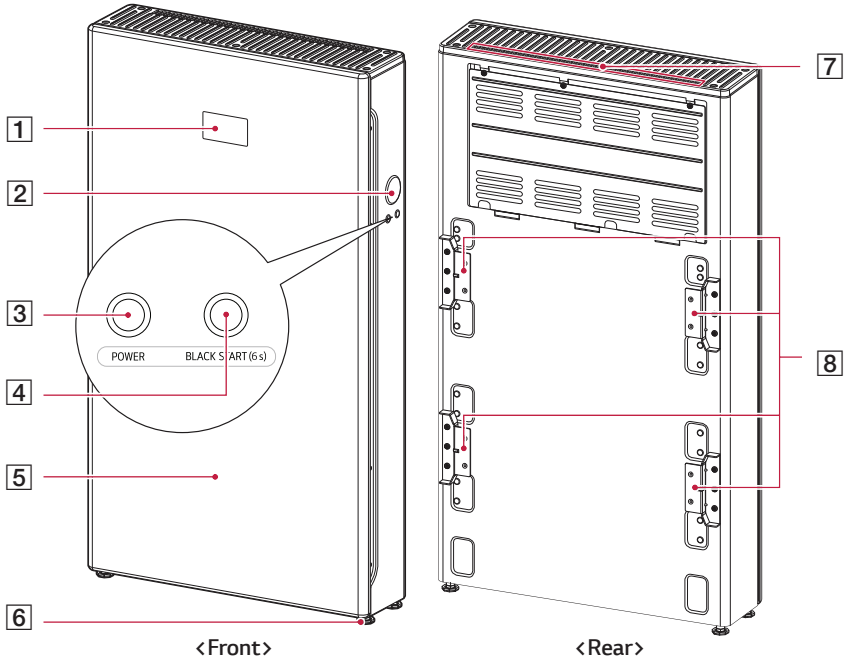

- 1** LED Indications
- 2** Conduit knockout
- 3** POWER button (Push type, ON/OFF toggle button)
- 4** BLACK START (6s) button (Momentary type, press and hold for 6 seconds)

- 5** Front cover
- 6** Height leveling adjustable leg
- 7** Ventilation openings
- 8** Bracket connected parts

Connection Parts (Home 8)

WARNING



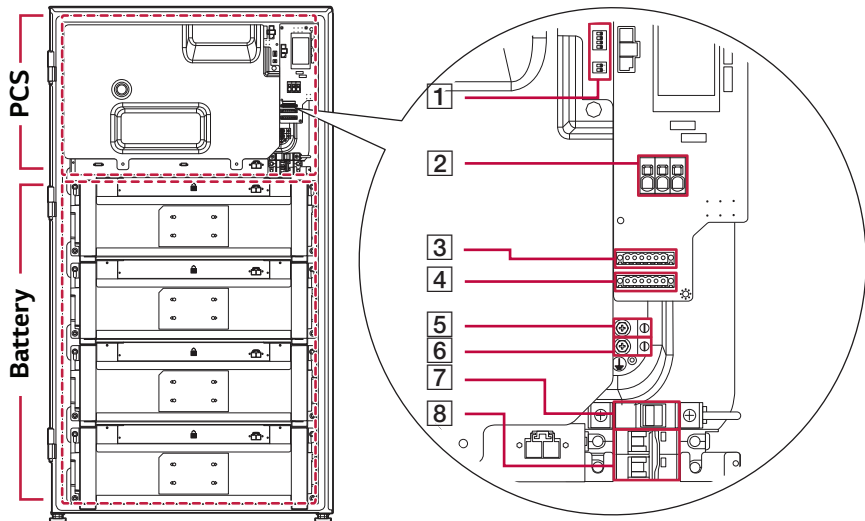

The battery packs and harness contain high voltages. Risk of death or serious injury due to electric shock. Before working on any Home 8 wiring, make sure the Home 8 battery circuit breaker is set to OFF.

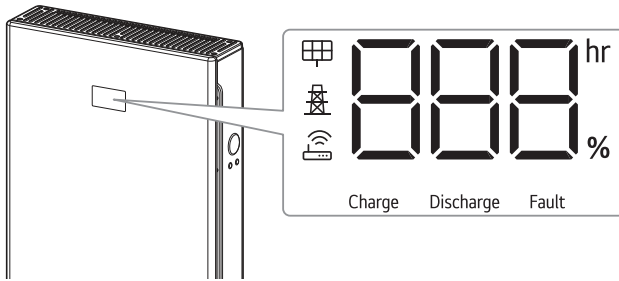

- 1** DIP switches
- 2** AC power terminals (L1, Neutral, L2) (CN_GRID)
- 3** Communication terminal block (to another Home 8) (CN_PCS)
- 4** Communication terminal block (to the SE Box) (CN_ATS)
- 5** Ground terminal (Protective Earth terminal, AC Power)
- 6** Ground terminal (Protective Earth terminal, Communication)
- 7** Battery fuse
- 8** Battery circuit breaker

LED Indications (Home 8)



LED	Status and Indications		
 (PV)	Green	Off	Red Blink + Error code
	Generating	Not generating	SE Box Fault
 (Grid)	Green	Off	Red Blink + Error code
	Normal	Abnormal	PCS Fault
 (Gateway)	On	Off	Red Blink + Error code
	Connected	Not Connected	Battery Fault
	SoC level + %	Remaining time + hr	Error code
	On-Grid	Backup operation	Fault
Charge	On	Off	
	BAT. Charging	Not operating	
Discharge	On	Off	
	BAT. Discharging	Not operating	
Fault	On	Off	
	Fault	Normal	

Front and Rear (SE Box)

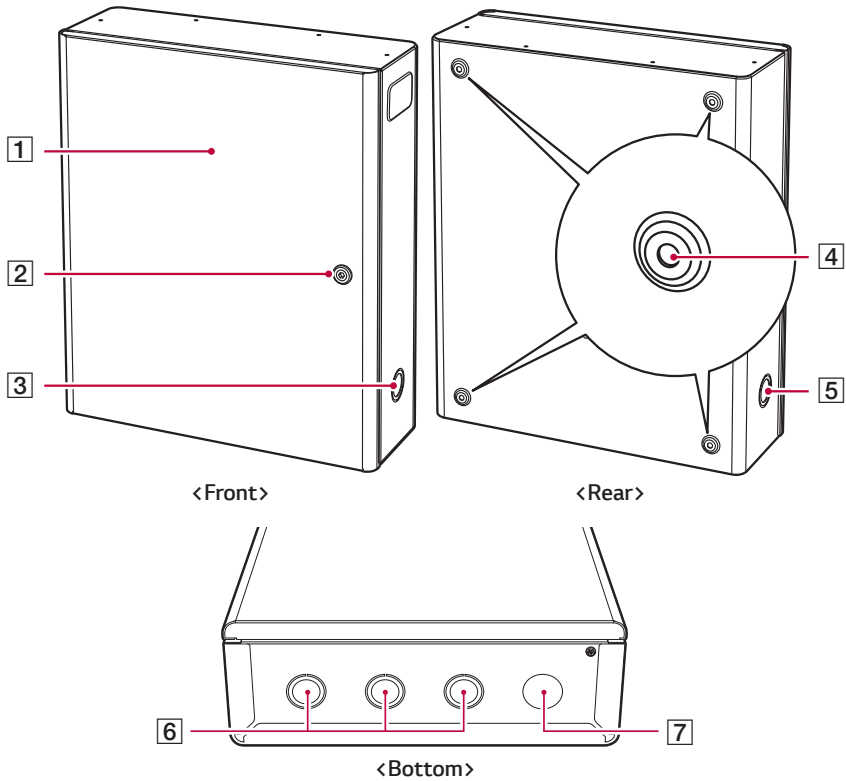

1 Front cover

2 Cover lock

3 Conduit knockout (right)

4 Wall support screw holes (4 points)

5 Conduit knockout (left)

6 Conduit knockouts (bottom)

7 Conduit hole (bottom)

Connection Parts (SE Box)

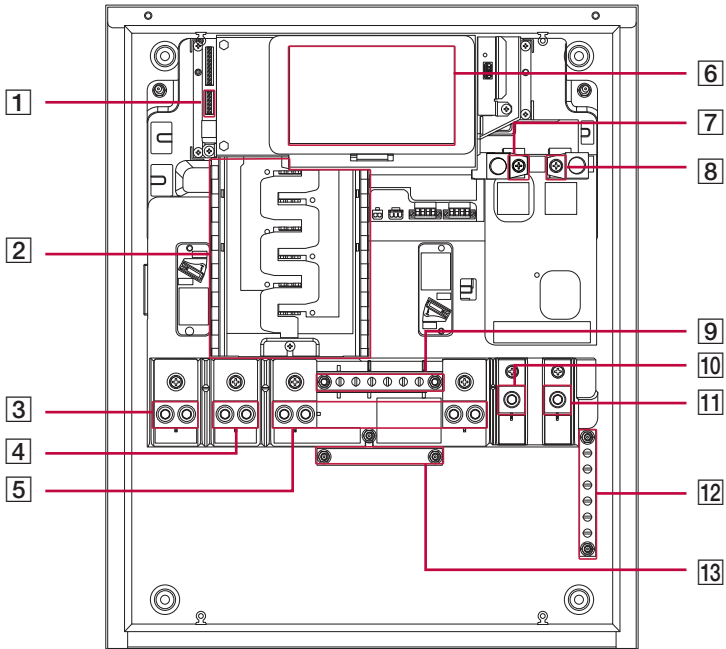

- | | |
|---|--|
| 1 Communication terminal (to Home 8)
(CN1000) | 8 Grid terminal (L1) |
| 2 Panelboard | 9 Neutral terminals for Home 8 and
PV inverter |
| 3 Backup load terminals (L1) | 10 Non-backup load terminals (L2) |
| 4 Backup load terminals (L2) | 11 Non-backup load terminals (L1) |
| 5 Neutral terminals for grid and load | 12 Ground terminals for grid and load |
| 6 HMI (Human Machine Interface) display | 13 Ground terminals for Home 8 and PV
inverter |
| 7 Grid terminal (L2) | |

Plan the Installation

1. Select Installation Location

- Select an appropriate installation location for the safe use of the product.
- For guidance on the selection of a proper environment, see "Installation location."
- The Home 8 unit must be installed on the floor with the wall support due to its heavy weight.
- Choose a leveled floor and wall capable of supporting the full weight of the Home 8 and SE box.
- Prepare appropriate screws, anchors, and additional supports for the wall type.

2. Plan the Cable Connection

- Determine the cable route for the connection to the SE Box.
- The SE box has 6 knockouts for connecting the conduit.
- The Home 8 has 1 hole for the 1.5 inch conduit.
- For detailed positions, refer to "Front and Rear (Home 8)" and "Front and Rear (SE Box)".

3. Plan the Conduit or Raceway

- Depending on the cable size and local code requirements, select the proper Conduit or Raceway size and amount.
- When installing a conduit or raceway as needed, the conduit adapter must be attached to the inlet of the wiring compartment.
- Conduit adapters are required for all installations, and NEMA Type 3R conduit adapters are needed when installing outdoors. (One for each used conduit opening.)

4. Distance Between Components

Follow the table below for the maximum allowable length between system components. Wire gauge must meet local codes and, in some circumstances, the wire gauge requirements change based on length.

Types of Connections	Maximum Cable Length
SE Box to Home 8 (Power)	Max 30 m (When multiple Home 8 units are installed, this max value is applied to each unit.)
SE Box to Home 8 (Communication)	Max 30 m (Total length of the communication cable, including daisy-chained connections, through the last Home 8 in the chain)
Wired Ethernet connection	Max 100 m
200A CTs to SE Box	Up to 30 m (Total length between CT and SE Box)
RS485 communication cable	Up to 30 m

Installation Location

Before installing the product, select an appropriate installation location for the safe use of the product.

The Home 8 and SE Box has been certified NEMA 3R and can be installed indoors as well as outdoors. However, if installed outdoors, do not allow the product to be exposed to water sources or continuously exposed to sunlight or other conditions that result in a consistent operating temperature below -10°C (14°F) or exceeding 45°C (113°F).

- Power limitation phenomena in the battery (with a resulting decrease in energy production by the system).
- Premature wear of the electrical/electromechanical and mechanical components.
- Reduction in performance, performance warranty, and possible damage of the battery



WARNING

- Install the unit considering the possibility of strong winds or earthquakes.
- The system should be installed according to NFPA 855.
- Do not install the product in a place where it is exposed directly to ocean winds. Sea salt in the air may cause the product to corrode.
- If the installation site is an area with heavy snowfall or a flooding area, make the foundation as high as possible.
- If the product is continuously exposed to sunlight or other conditions that result in a consistent operating temperature below -10°C (14°F) or exceeding 45°C (113°F), it may degrade the performance and life cycle.

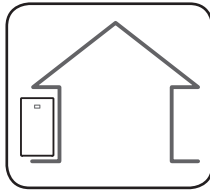
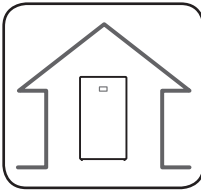

- This product is designed to be installed for indoor/outdoor use.
- Install this product in the place where PV cables, energy meter cables, grid cables and battery cables are easily accessible.

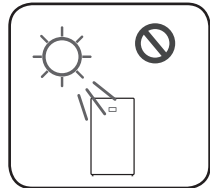
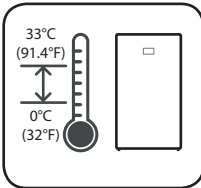

- The recommended operating temperature range is from 0°C to 33°C (32°F to 91.4°F).
- Avoid installing this product in a location exposed to direct sunlight.

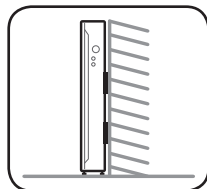

- This product is designed to be installed on the floor standing with a wall support. Do not install this product laying on its side.
- This product must be install on a leveled floor and the mounting surface must be able to support the weight of the product. (approx.165 kg (364 lbs))

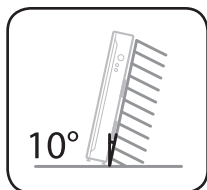

- Do not install the product on the ceiling.
- Do not install the product widthwise or install on a wall with a lean of more than 10 degrees.
- Do not install the product tilting forward.

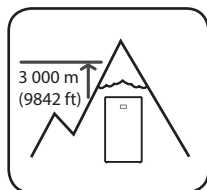

- This product must be installed or used at an altitude of less than 3,000 m (9,842 ft).



- Do not install this product in an area prone to flooding

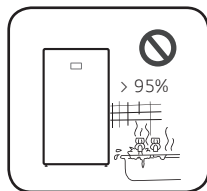

- Do not install this product in a highly humid area such as a bathroom.
- Do not install the product in an area with vibrations.

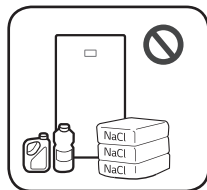

- Do not install this product in a place with ammonia, corrosive vapours, acids, or salts.
- Install this product out of reach of children and pets.

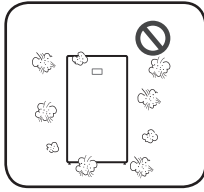

- Do not install this product in places or environments subject to the heavy build-up of dust.
- Do not block the air ventilation openings for cooling.
- When cleaning the air duct, shut off all of the systems including the Home 8 and SE Box.

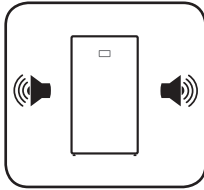

- This product generates some noise at times and should not be installed close to living or sleeping areas.
- Please consult the location with your installer when installing in places subject to noise sensitivity.

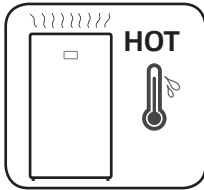

- The upper side of the installed Home 8 can become hot due to the heat from the air outlet. Do not place any object near the air outlet.

Distance Between Components

Follow the table below for the maximum available length between system components. Wire gauge must meet local codes and in some circumstances wire gauge requirements may change based on length.

Types of Connections	Maximum Cable Length
SE Box to Home 8 (Power)	Max 30 m (When multiple Home 8 units are installed, this max value is applied to each unit.)
SE Box to Home 8 (Communication)	Max 30 m (Total length of the communication cable, including daisy-chained connections, through the last Home 8 in the chain)
Wired Ethernet connection	Max 100 m
200A CTs to SE Box	Up to 30 m (Total length between CT and SE Box)
RS485 communication cable	Up to 30 m



CAUTION

If do not follow maximum cable size and length requirements, it may result in intermittent or unreliable operation of the Home 8 system. In systems that do not meet these minimum requirements, performance issues may arise even after successful commissioning.

Minimum Clearance

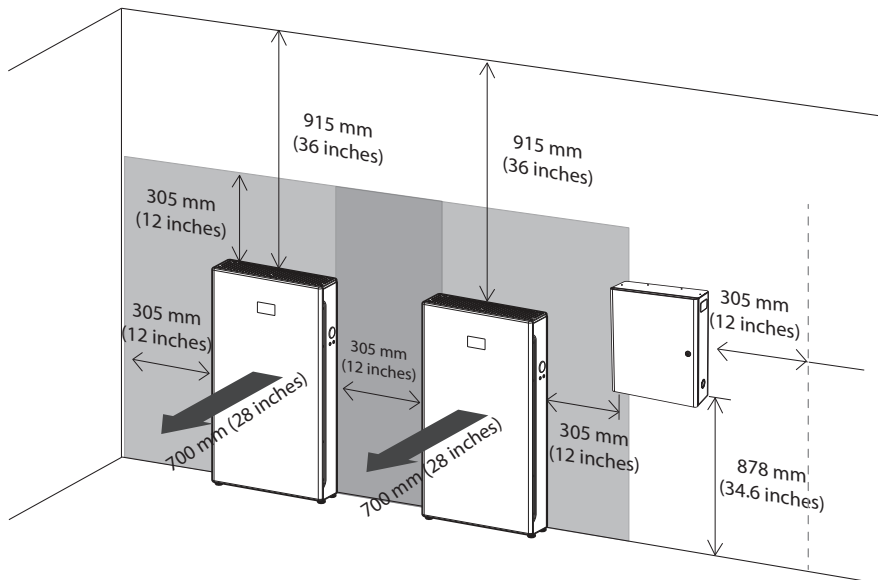

This product must be installed with clearance at the left, right, top, bottom and front of the product as shown in the figure.

Make sure to keep at least a 305 mm (12 inches) distance between Home 8 units and between Home 8 and other devices.

Keep at least a 700 mm (28 inches) distance between the front door and any obstacles in order to allow space for installation and servicing.

If the door is closed, all other products should be at least 305 mm (12 inches) from the front door for safety operation.

Ensure that the distance between the wall and Home 8 is at least 25 mm (1 inch).

Be sure not to place any object on top of the Home 8 to prevent risk of fire or serious injury due to high temperature.

If the ESS is installed outdoors with eaves, there must be at least a 915 mm (36 inches) clearance to the eaves.

The National Electric Code may require significantly larger working clearances (see NEC Section 110.26).

INFO

When installing the product in a garage, a vehicle crash protection guide must be installed to disassemble for the repair and replacement of the product.

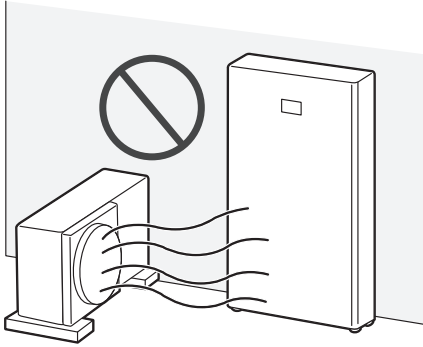

When installing the Home 8 next to an air conditioner outdoor unit, install the Home 8 in a position that avoids any hot air expelled from the air conditioner outdoor unit.

Floor Standing Wall Support

The Home 8 unit must be installed on the floor with the wall support due to its heavy weight. The proper environments described in "Installation Location" must be considered. Be sure to follow the instructions exactly.

Mounting the Home 8

WARNING

- It is important to ensure that the drilling locations are not located on any electrical wiring or plumbing inside the wall.
- Align both bracket positions correctly. If the bracket positions are not correct, the Home 8 may not be mounted properly.
- The system must be installed according to NFPA 855.

CAUTION

- Make sure the screws, anchors, and additional supports are appropriate for the wall type.
- Make sure the pilot hole size matches the anchor type.
- The weight of the Home 8 is 163kg (359 lbs), and the SE Box is 25 kg (55 lbs). The wall must contain blocked studs that can bear the weight and are of masonry or other suitable structures.

INFO

- When attaching the wall bracket to a wall, adjust the horizontal level using an inclinometer or a leveler.
- When indicating the position to drill, you can refer to the Mount Hole Guide which is a true to scale print of the actual wall bracket if required.
- The Mount Hole Guide is in the SE Box accessory package.
- Before fixing the bracket screws, check the horizontal level once again using an inclinometer or a leveler.
- Depending on the surface, different screws and anchors may be required for installing the wall bracket. Therefore, these screws and anchors are not contained in the product. The system installer is responsible for selecting the proper screws and anchors.
- It is recommended to use stainless steel screws which are 8 mm (5/16 inch) and 76 mm (3 inch) in length.

INFO

- The following images are for reference. For safe installation, the installers must assess whether additional fixing is required.

- 1 Place the wall bracket on a wall which meets every installation condition and clearance requirement.

Indicate the positions to drill using a pencil or other writing utensil. Drill holes in the indicated positions. It may help to use the true to scale print of the actual wall bracket which provides the hole positions included in the package.

Refer to "Mounting details for wall brackets" for more information.

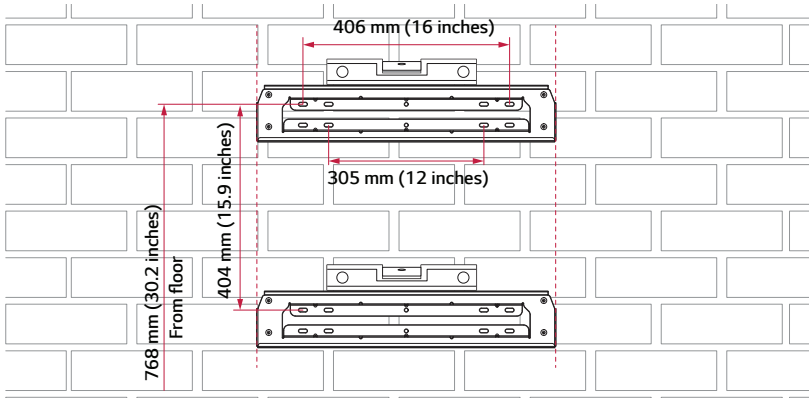

- 2 Affix the wall bracket to the wall with screws or anchors. Align the upper and lower brackets so that they are straight vertically.

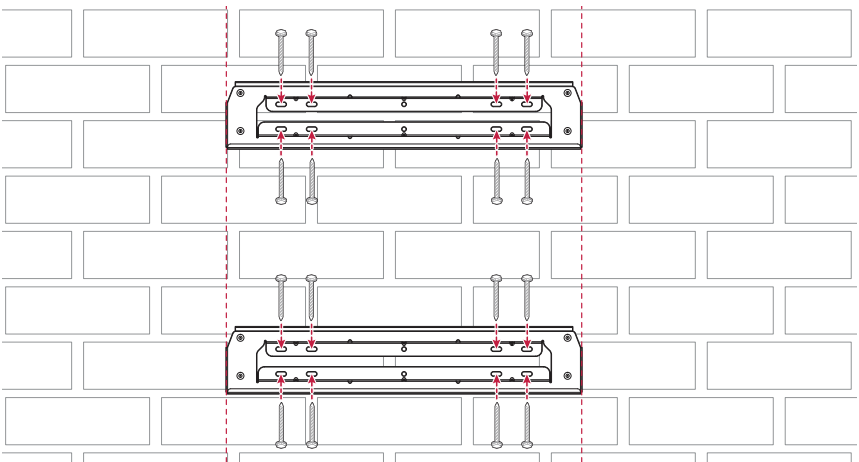

! WARNING

- The Home 8 must be installed on the floor due to its the heavy weight. Wall supporting is only for supporting purposes.
- If installation is difficult due to a Stem Wall, reinforce the wall or floor to ensure proper installation.
- Be sure the floor is hard enough to support the weight of the Home 8.
- Rotate the legs at the bottom of the Home 8 to adjust the level.

! CAUTION

- The Home 8 is very heavy. Serious injury may occur due to the heavy weight when mounting it to the wall. Therefore, special care must be taken in handling. Make sure to use the lift instead of using human strength when installing.
- When hanging the Home 8 on the wall bracket, slowly lower the Home 8 and make sure the Home 8 is properly mounted on the wall bracket.
- If 4 points on the wall brackets (both sides of the 2 wall brackets) are not properly fixed to the wall, the product may fall over.

i INFO

In areas where installation is difficult due to the heavy weight of the Home 8, the battery can be disassembled and installed. Refer to the "Battery Pack Disassembly Guide" for battery disassembly.

- 3 Hang the Home 8 on the wall bracket using the lift.
Then rotate the legs to bring the Home 8 level with the floor.

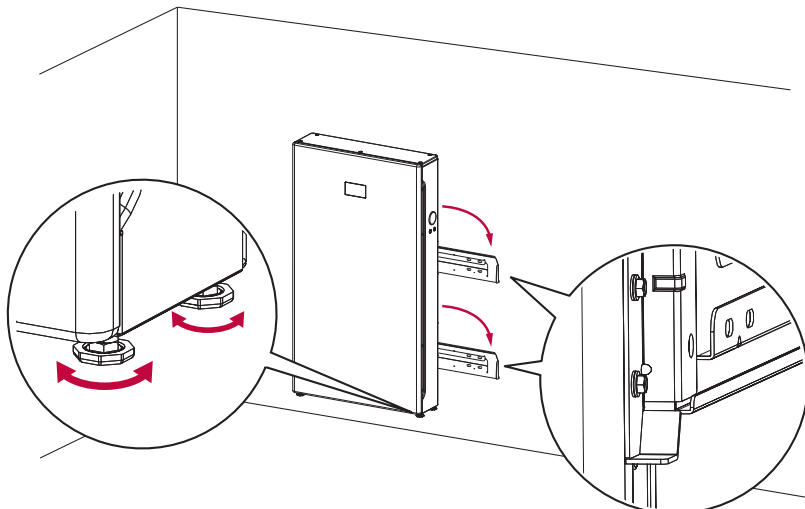

⚠ WARNING

- Before making a connection to the Home 8, make sure that the battery circuit breaker is OFF. If the circuit breaker is ON, death or serious injury may occur due to electric shock.
- High voltage is energized through the internal battery module and wiring. Special care must be taken when working on a Home 8 connection.
- High voltage may be energized inside the safety cover. Do not open the safety cover of the Home 8.

- 4 Install a conduit as needed and attach the conduit adapter to the inlet of the wiring compartment. The wiring compartment inlet accepts a standard 1.5 inch conduit adapter. (The following is an example of possible conduit installation. Depending on the site, the required conduits and the knockout position of the SE box may vary.)

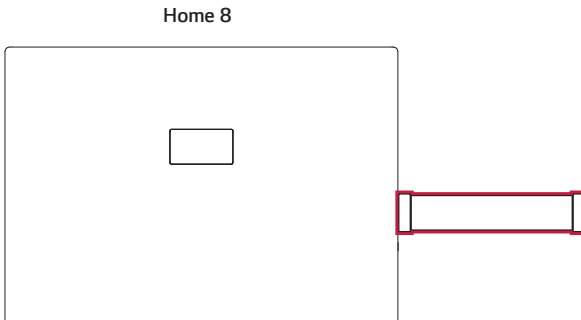

i INFO

After installing a conduit on the side of the Home 8, decide the installation location of the SE Box considering the conduit position.

Mounting details for wall brackets

INFO

- Refer to local building codes for the appropriate fastener.
- Below are the minimum guidelines for mounting and are not guaranteed to ensure proper mounting.
- Screws must be placed balanced in each corner.
- Ensure that the screw positions are at the center of the studs when anchoring to studs.

Wall Type	Screw	Length (Minimum)	Number of screws
Wood Studs	M8 (5/16 inch) Lag screws with washers	76 mm (3 inches)	8
Concrete or Masonry	M8 (5/16 inch) Concrete fasteners with washers	63 mm (2.5 inches)	16

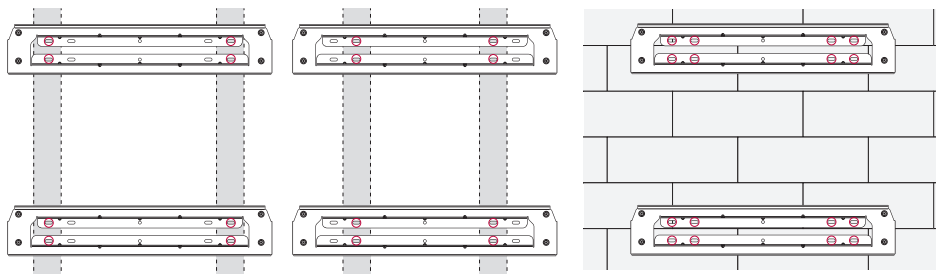

Mounting the SE Box

- 1 Use a 8 mm (5/16 inch) hexagon wrench to open the door. Then remove the safety cover's 4 screws using a Phillips screwdriver.

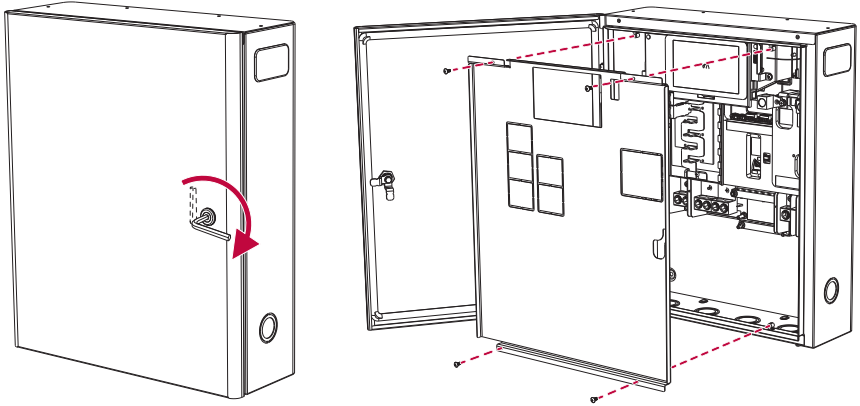

CAUTION

When opening the door, do not use any tool other than an 8 mm hexagon wrench and do not apply too much force. It may cause the lock to break.

- 2** Place the SE Box on a wall which meets every installation condition and clearance requirement.

Mark the positions to drill using a pencil or other writing utensil. Drill holes in the indicated positions. It may help to use the true to scale print of the SE Box which provides the hole positions included in the package.

(The following is an example of possible conduit installations. Depending on the site, the required conduits and knockout position of the SE box would vary.)

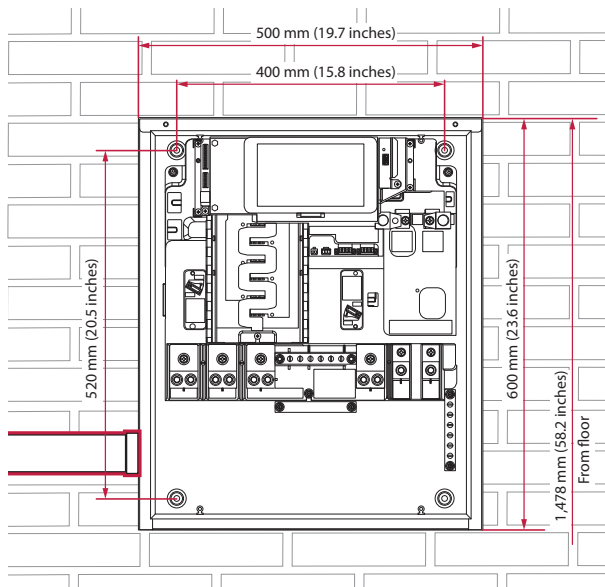

! WARNING

- Take care in holding the product when mounting the SE Box as it is heavy. It may cause injury.
- Do not hold the door when mounting. Do not hang anything on the door. It may lead to deformation or fracture.
- It is important to ensure the drilling locations are not located on any electrical wiring or plumbing inside the wall.

! CAUTION

Be careful not to be injured by the sharp edge when make the conduit hole or connecting a conduit.

- 3** Fix the SE Box with 4EA screws and anchors with O-rings in each position. Before fastening the screws, place the supplied O-rings on the screws.

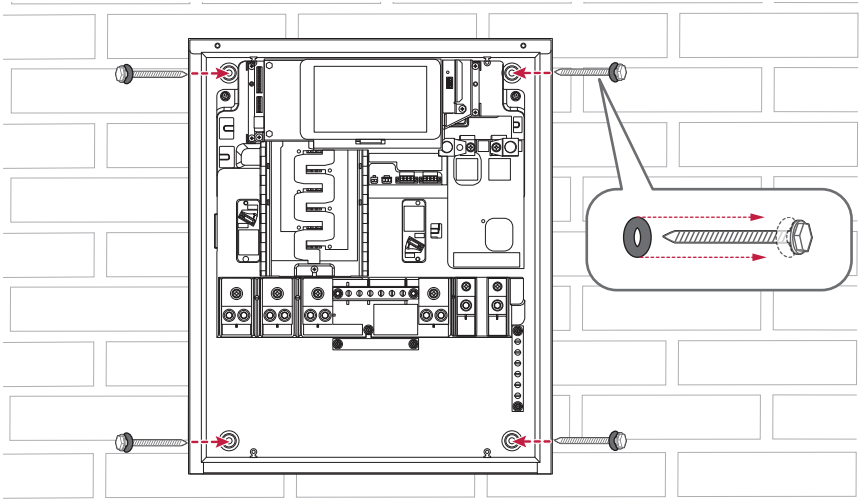

INFO

- The O-rings must be installed to meet the NEMA 3R requirements when fastening the mounting screws. The mounting screws should be chosen considering the O-ring. The internal diameter of the O-ring is the 8 mm (5/16 inches).
- Adjust the horizontal level using an inclinometer or a leveler when attaching the SE Box to a wall before fixing the screws.
- Depending on the surface, different screws and anchors may be required for installing SE Box. Therefore, these screws and anchors are not included.
- The system installer is responsible for selecting the proper screws and anchors.
- It is recommended to use stainless steel screws which are 8 mm (5/16 inch), 76 mm (3 inch) in length and have a head diameter of more than 16mm (15/64 inch).

Connections

Whole Home Backup (Service Equipment)

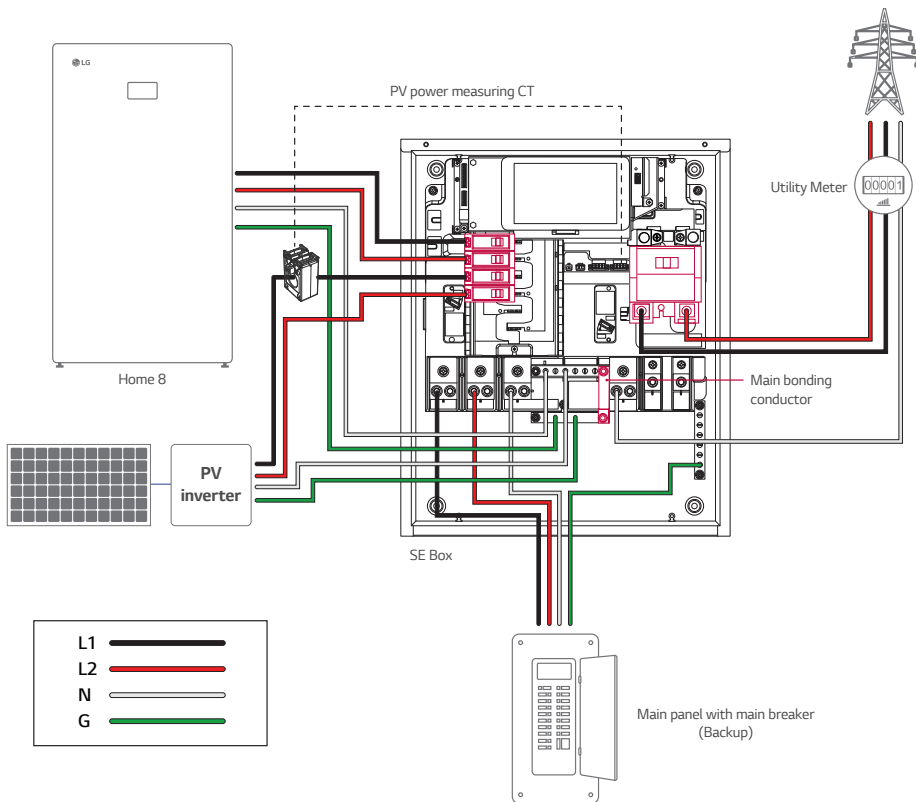

Service Equipment Preparation (If Required)

Neutral-Ground Bonding Busbar Connection

If not needed as a service equipment, this step may be skipped.

A proper earth connection and N-GND Bonding busbar connection are required for safe operation of the system and for compliance with local code requirements.

If the system is installed as service equipment, connect the Neutral and Ground terminals on the SE Box using the provided N-GND bonding busbar (Cross-sectional area: 45 mm²).

- 1 Remove the two nuts positioned in the figure.
- 2 Assemble N-GND bonding busbar on Neutral and Ground terminals and fasten the two nuts.

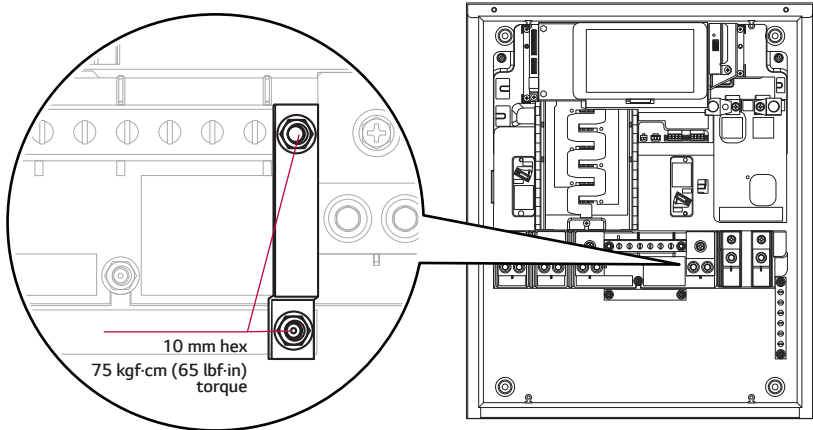

WARNING

To ensure the safe operation in backup mode, a local earth connection must be present on the site such as an earth rod or ground electrode. Connection of the earth rod must comply with local regulations.

SE Box Main Breaker Installation

If the system is installed as service equipment, a main breaker must be installed.

LGEUS does not provide the main breaker.

- 1 Remove the L1 and L2 lugs on the supply side using a 10 mm hex socket wrench.
- 2 Install a compatible main breaker by fastening the 2 nuts.

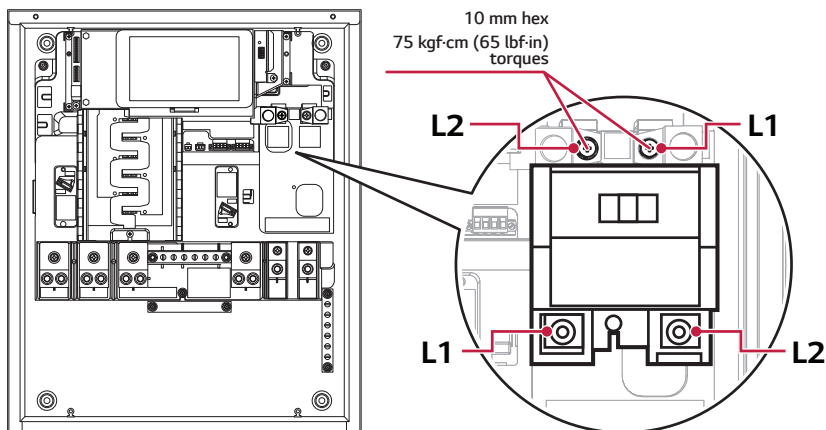

WARNING

Before mounting a main breaker in an electrical system, make sure there is no voltage present where work is to be performed. The voltage in energized equipment may cause injury or death.

INFO

- Main breaker terminal insulators are recommended any time a main breaker is installed in the SE Box.
- Eaton® CSR or BW type breakers can be used. Refer to "Compatible Eaton Parts" for breaker types and required accessories.

Internal Panelboard and Additional Fastener

SE Box has an internal panelboard, where Eaton BR circuit breakers and BRS225 / BRPSF225 (sub-feed lug block) can be installed. The internal panelboard provides 5 spaces for 2-pole breakers as shown in the following diagram (1 - 5).

Use hold down kit (Eaton BRHDK125), when an additional fastener is required for the circuit breaker to comply with NEC and the local code. This hold down kit can be used in placement of 1 - 3 only.

Use 4 - 5 placements stainless steel screws with, when the sub-feed lug block may be needed to install multiple Home 8 units and PV inverters. It is recommended that the terminal of the lug block should head to the right in consideration of wire bending space.

Do not connect the load to the internal panelboard to insure the stable operation of the whole system.

The ampacity sum of the circuit breakers should not exceed 200Amps. If a 200A circuit breaker is used at the main breaker load center connected to the lug block, no additional circuit breakers should be installed on the internal panelboard.

Following the NEC and local codes is first priority.

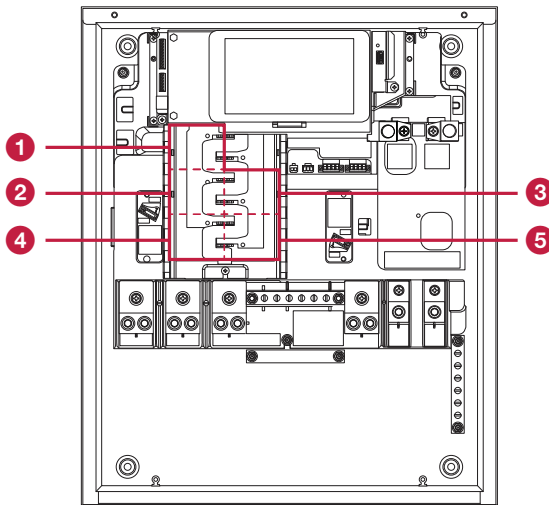

Wiring Connection between the SE Box and Home 8

This is an example of 1 Home 8 connection. For multiple Home 8 connections, please refer to "Multiple Home 8 Units or PV Inverters Connection".

WARNING

- The system wiring must follow ANSI/NFPA 70 and other local codes.
- Conduit adapters are required for all installations, and NEMA Type 3R conduit adapters are needed when installing outdoors. (One for each used conduit opening.)
- Required when torquing connections
 - Follow NEC 2017 110.14(D)
 - A well-calibrated torque tool must be used to achieve the indicated torque values.
 - Use tamper-proof torque mark/paint after torquing connections.
- Class 1 wiring methods are to be used for field wiring connections to terminals of a Class 2 circuit.
- The AC output should be isolated from the enclosure and system grounding.

INFO

- Refer to "Wiring Reference" for wiring specifications.
- The wiring images are pictures to help your understand and they may be different from the actual work.

- 1 Connect the conduit to the SE Box.

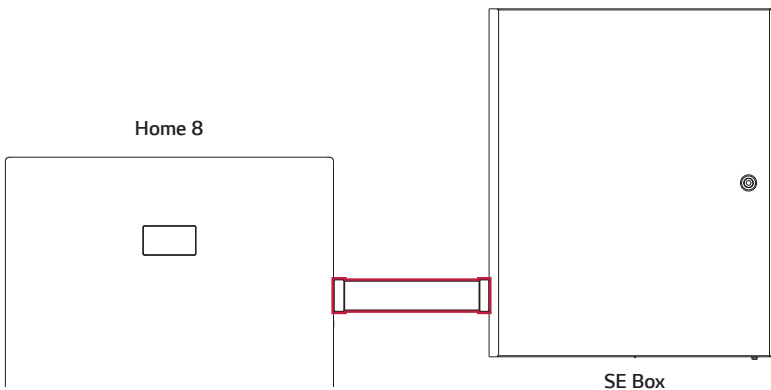

! WARNING

- Before making a connection to the Home 8, make sure that the battery circuit breaker is OFF. If the circuit breaker is ON, death or serious injury may occur due to electric shock.
- High voltage is energized through the internal battery module and wiring. Special care must be taken when working on a Home 8 connection.
- High voltage may be energized inside the safety cover. Do not open the safety cover of the Home 8.

- 2** Remove the screws on the right side and open the front cover of the Home 8.
(Hex socket : M8)
Before starting the wiring, make sure the circuit breaker of the Home 8 is OFF.

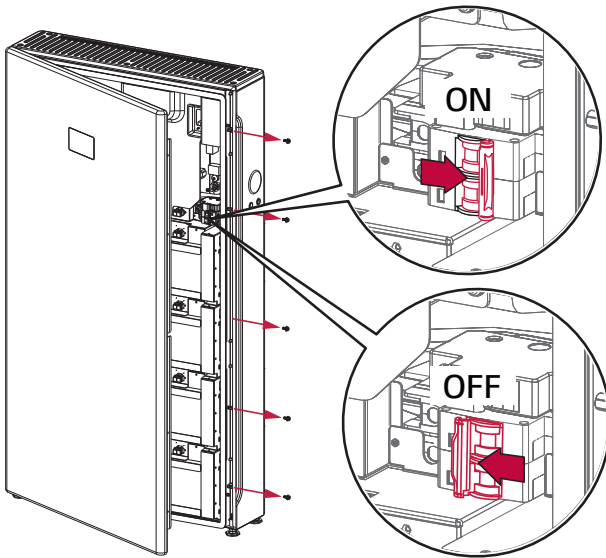

- 3 Pass the 6-conductor communication cable and the AC power conductors (L1, L2, Neutral and Ground) through the conduit installed between the Home 8 and SE Box.

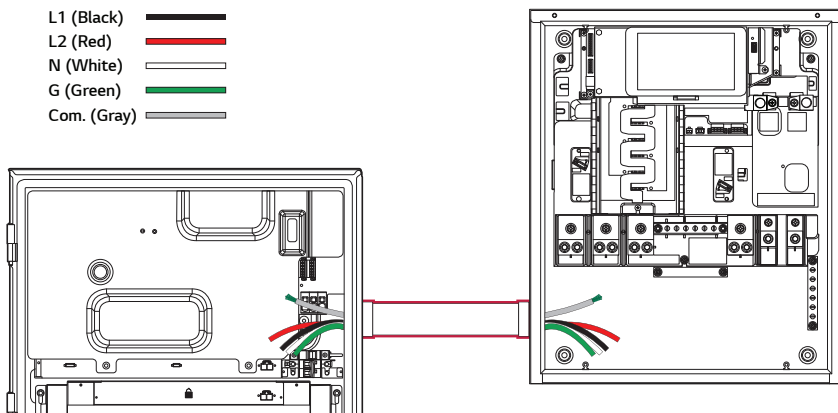

- 4 Strip off the AC power conductors (L1, L2, Neutral, and Ground) on both the Home 8 and SE Box sides as shown in the figure below.

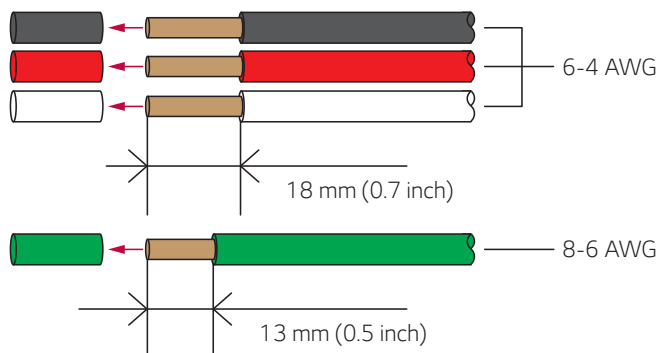

- 5 On the Home 8 side, connect the AC conductors to the corresponding terminals as shown in the figure below.

There are two ground terminals on the Home 8 side. Connect the AC power ground to the upper ground terminal.

The ground terminals are identified with the following symbol: 

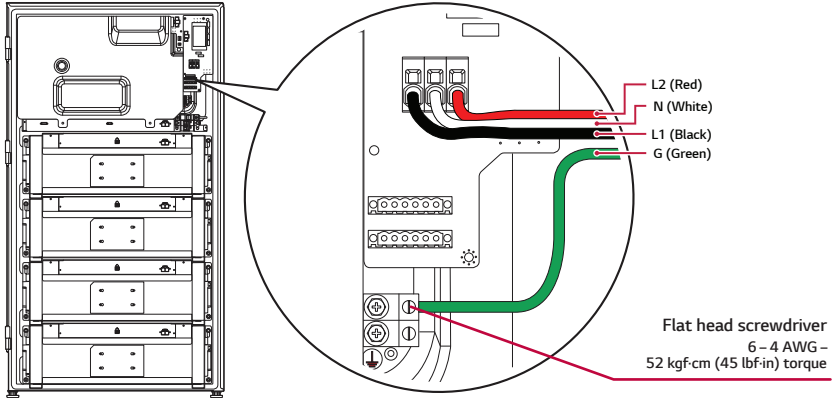

- 6 On the Home 8 side, strip the 6-conductor communication cable and wind up the communication wires and drain wire using insulation tape as shown in the figure. When taping the communication wire, wrap the remaining wire and cover it with insulation tape. Connect the 6-conductor communication wires to the communication terminal block as shown.

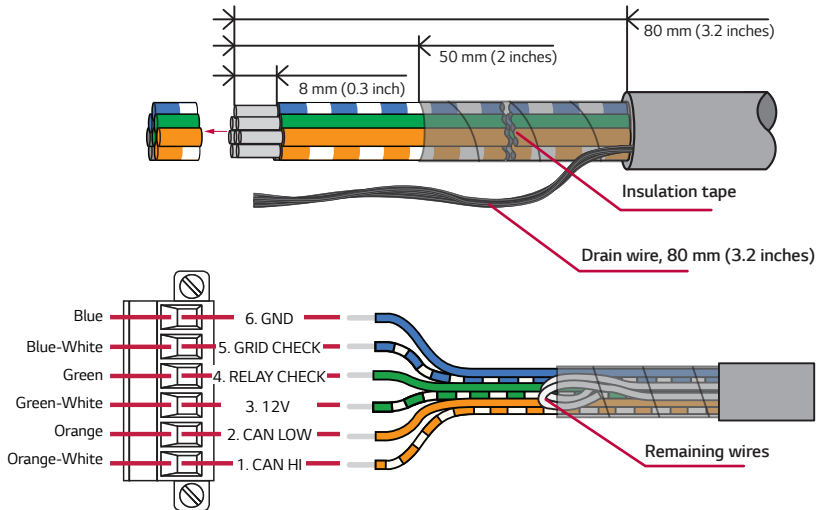

- 7 On the SE Box side, strip the 6-conductor communication cable as shown in the figure.

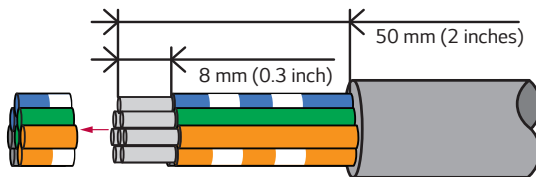

- 8 Plug the green terminal block into the communication socket.
Connect the drain wire to the lower ground terminal as shown in the figure.

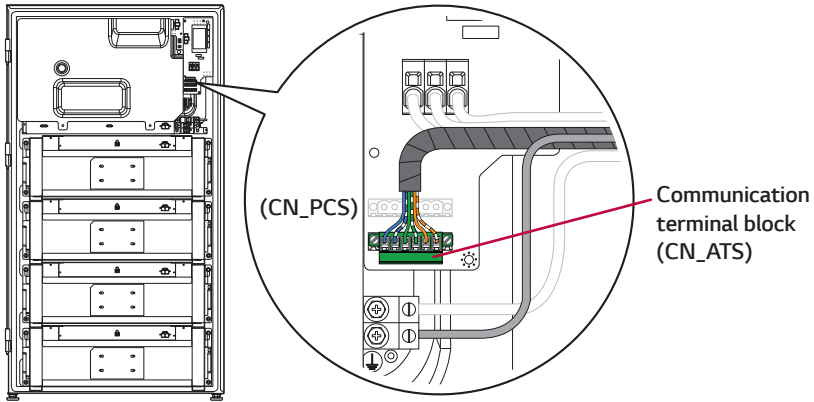

CAUTION

When you install multiple Home 8 units, the DIP switch settings on each Home 8 should be different.

- 9 Set the terminating resistor for CAN communication by using a DIP switch. When multiple Home 8 units are installed, this terminating resistor should be ON in the last Home 8 in the daisy chain.
Refer to "Multiple Connection ID Setup Method" for more information.

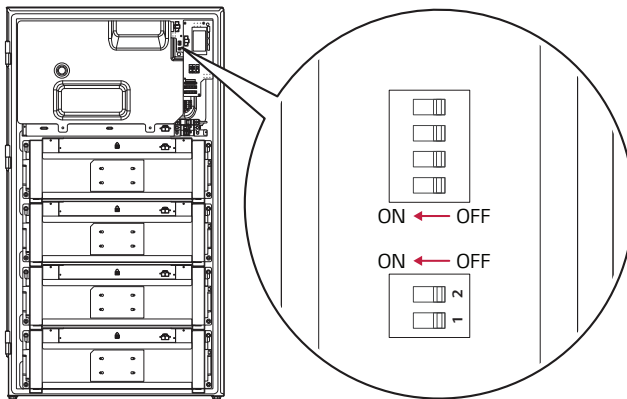

- 10 To make an electrical connection between the Home 8 and SE Box, installing the required ampacity circuit breakers on the SE Box is required. (40A breaker is required.) Install a 40A circuit breaker in the Home 8 as shown in the following figure.

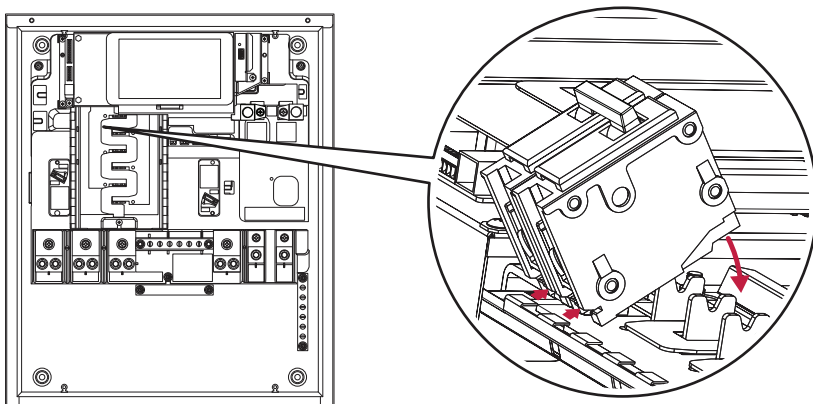

- 11 On the SE Box side, connect the AC conductors to the corresponding terminals as shown in the figure.

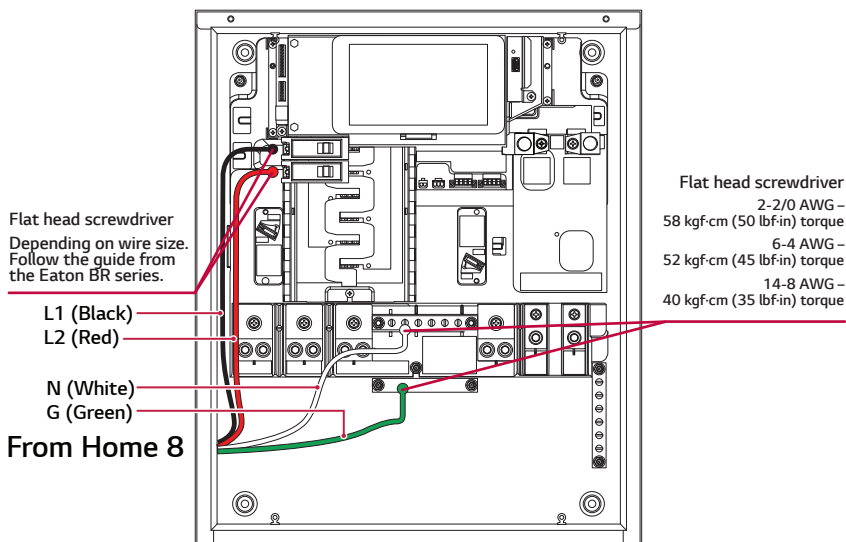

CAUTION

Before inserting the cable conductors to the terminals, loosen the screw and then fix the screws tightly. Shake the cable to check the connection status.

12 At the end of the 6-conductor communication cable on the SE Box side, insert the wires into the 6-position connectors as shown in the figure.

Fix the cable in the upper hook as shown in the figure. Arrange the cable between the plastic case and metal enclosure.

Cut back the drain wire and shield. The drain wire should be terminated at the Home 8 chassis ground terminal only.

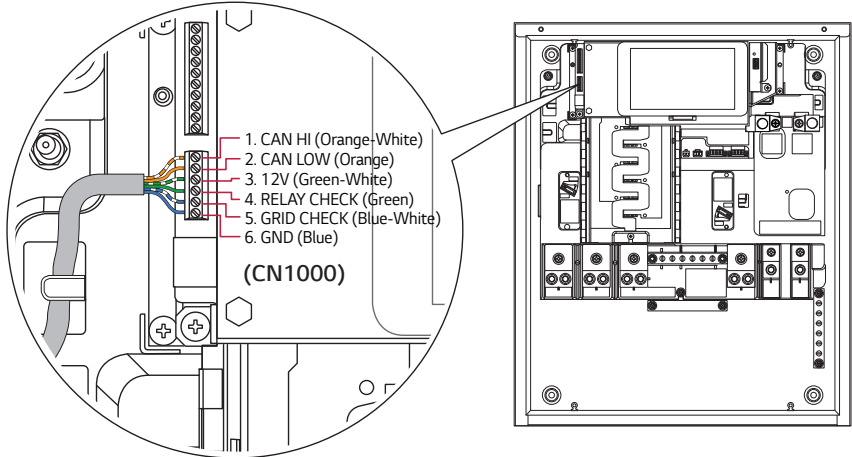

Grid and Load Connections

INFO

- Must use copper or aluminum wire rated at 90 °C (194 °F) for the AC power connection.
- Strip the ends of the wires and insert into the corresponding SE Box terminal lugs.
- Using the proper torque tool, tighten the lugs according to the table on the following page.

- 1 Connect the grid conductors (L1, L2, Neutral, and Ground) to grid terminals in the SE Box as shown in the following figure.

When a main breaker is required, install the main breaker ahead of wiring connection. Please refer to "SE Box Main Breaker Installation". (Follow the local code.)

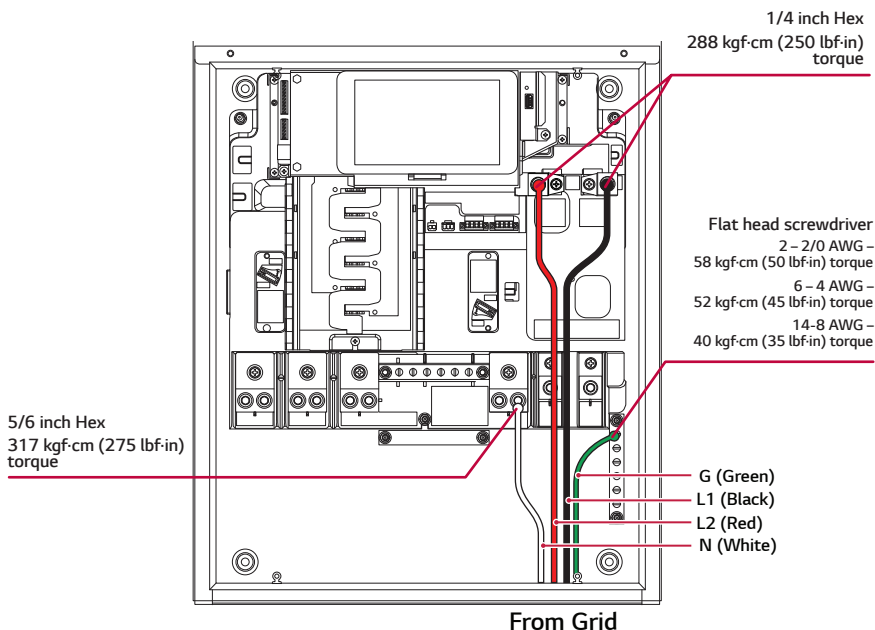

- 2 Connect the home load conductors (L1, L2, Neutral, and Ground) to the SE Box backup load terminals as in the following figure.

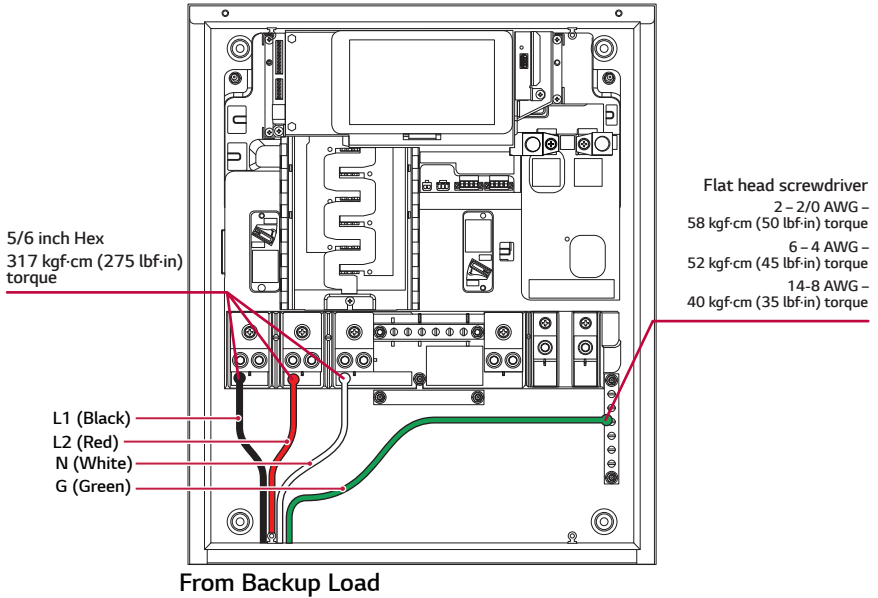

INFO

There are 6 conduit knockouts on the left, right, and bottom of the SE Box. Select the appropriate conduit knockouts and grounding location so that the cables are not twisted.

	Knockout Position	Recommended Conduit Body Index Size
Home 8	-	1 ½ inch
SE Box Side Hole	Inner	1 inch
	Outer	1 ½ inches
SE Box Button Hole	Inner	1 ½ inches
	Outer	2 inches

- 3** For partial home backup with non-backup loads under 100A, a non-backup panel can be connected to the SE Box (The total load should not exceed 200A). Connect the non-backup load conductors (L1, L2, Neutral, and Ground) from the non-backup panel to the SE Box non-backup load terminals as in the following figure.

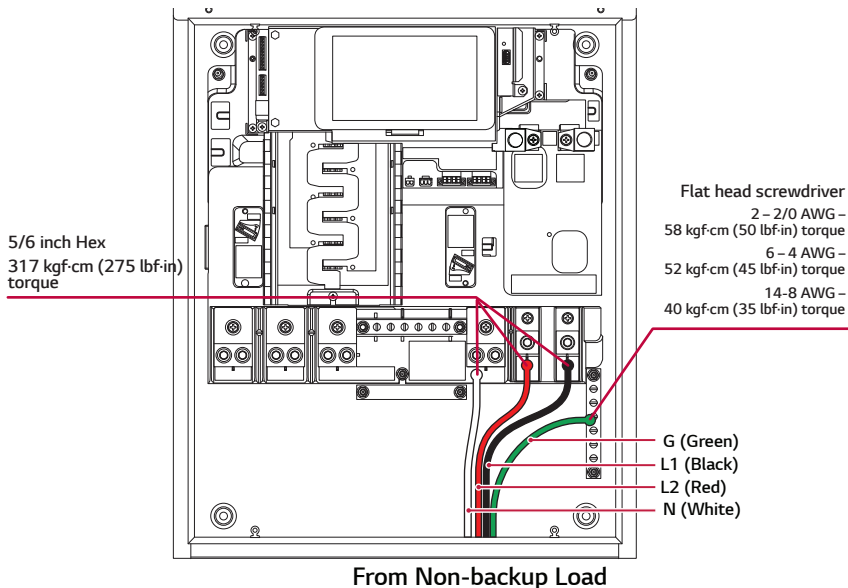

INFO

There are 6 conduit knockouts on the left, right, and bottom of the SE Box . Select an appropriate conduit knockouts and grounding location so that the cables are not twisted.

Any circuit connected to the SE Box will not be powered when disconnected from the grid. During on-grid operation, these circuits are still metered by the internal site net metering with no additional metering hardware required.

However, if non-backup load panels exist upstream of the SE Box, additional CTs are required. In this case, refer to "Usage of External CTs".

Terminals	Wire Gauge	Tool Size	Strip Length	Torque
Grid lug (L1, L2)	6 AWG ~ 300kcmil	1/4 inch Hex	32 mm (1.25 inches)	288 kgf-cm (250 lbf-in)
Non-Backup Load Lugs (L1, L2)	6 AWG – 250 kcmil	5/6 inch Hex	32 mm (1.25 inches)	259 kgf-cm (225 lbf-in)
Backup Load Lugs (L1,L2)	6 AWG – 250 kcmil	5/6 inch Hex	32 mm (1.25 inches)	317 kgf-cm (275 lbf-in)
Large Neutral Lugs	6 AWG – 250 kcmil	5/6 inch Hex	32 mm (1.25 inches)	
Medium Neutral Lugs	14 AWG – 2/0 AWG	Flat head Screwdriver (6 mm)	20 mm (3/4 inches)	2 – 2/0 AWG – 58 kgf-cm (50 lbf-in) 6 – 4 AWG – 52 kgf-cm (45 lbf-in)
Earth Lugs	14 AWG – 2/0 AWG	Flat head Screwdriver (6 mm)	20 mm (3/4 inches)	14-8 AWG – 40 kgf-cm (35 lbf-in)

 **INFO**

- Refer to "SE Box Wiring: Power" for all wiring requirements and recommendations, including wire colors and gauges.
- Refer to "Whole Home Backup (Service Equipment)" for example system wiring diagrams.

Connect to PV Inverter

This is an example of a 1 PV inverter connection. For multiple Home 8 connections, please refer to "Multiple Home 8 Units or PV Inverters Connection".

INFO

- PV inverters must support a Frequency-Drop or Frequency-Watt functions.
- Make sure the PV inverter is a product that satisfies UL1741SA or UL1741SB.
- Make sure that the Frequency-Drop or Frequency-Watt function is enabled in the PV inverter configuration.
- If the PV inverter does not support this function or the function is turned off, the product may malfunction during the backup operation.
- A PV inverter that does not support a Frequency-Drop or Frequency-Watt function may be connected to a non-backup port in the SE Box or a non-backup load panel.

- 1 Install the circuit breaker for the PV inverter as shown in the figure. Follow local codes when selecting the circuit breaker ampacity.

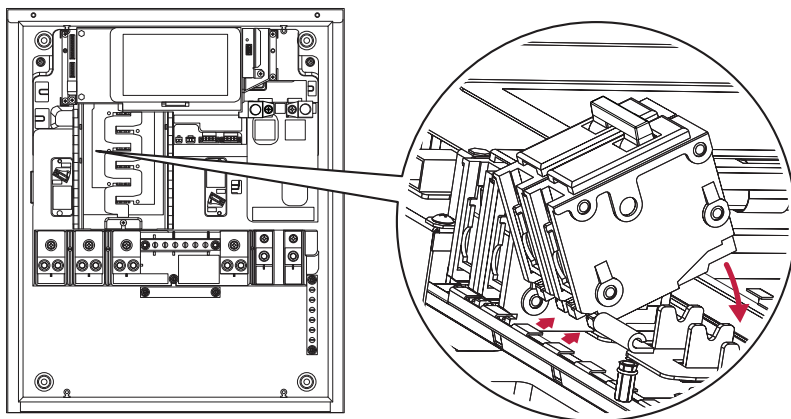

- 2 Pass the PV L1 cable from the PV inverter through the 200 A CT as shown below. The side with the markings P1 and K on the CT faces the PV inverter, and the side with the L and P2 faces the SE Box.

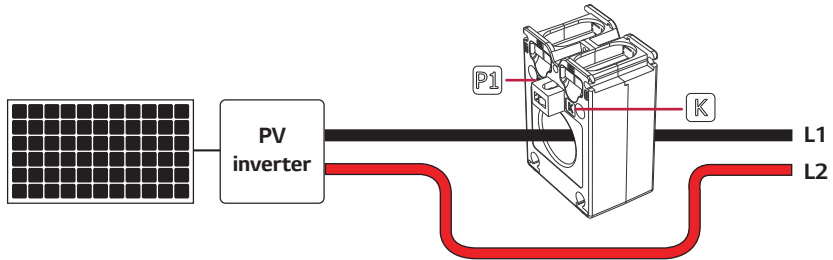

CAUTION

- Make sure the CT sensor's direction is correct.
- Fix the CT sensor and the L1 cable with a cable tie and position the CT sensor inside of the SE Box.

INFO

Make sure the CTs are facing the proper direction as described in this manual. A CT will show a negative current if installed in reverse.

- 3** Using the supplied CT Harness, connect it to the upper side of the CT. When wiring, refer to the figure below for the direction of the Ring Terminal.

S1 : Black (PV L1+), S2 : White (PV L1-)

Ring terminal: stud size - 1/4 inch, wire range - 18AWG

By using the sealable covers included in the CT packaging box, protect screw terminals to always assure the best safety. Refer to the manual included in the CT package to assemble the sealable covers.

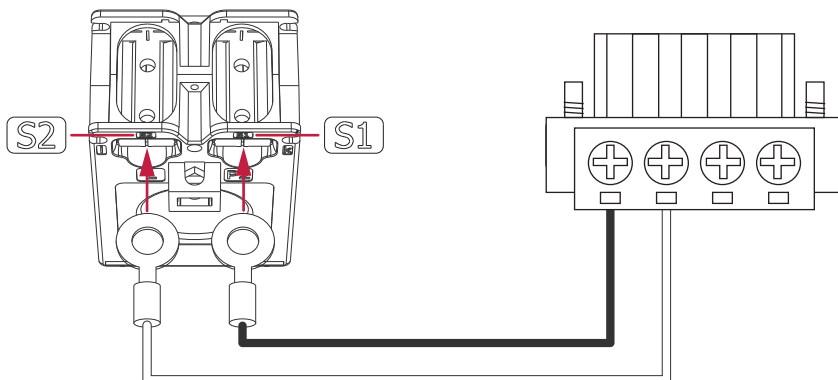

- 4** After connecting the end of the CT Harness to pins 1 and 2 of the terminal block for PV CT in the SE Box, respectively, S1 (PV L1+) and S2 (PV L1-), plug it into the connector and tighten the screws on both sides of the terminal block.

Fix the cable in the hook as shown in the figure below.

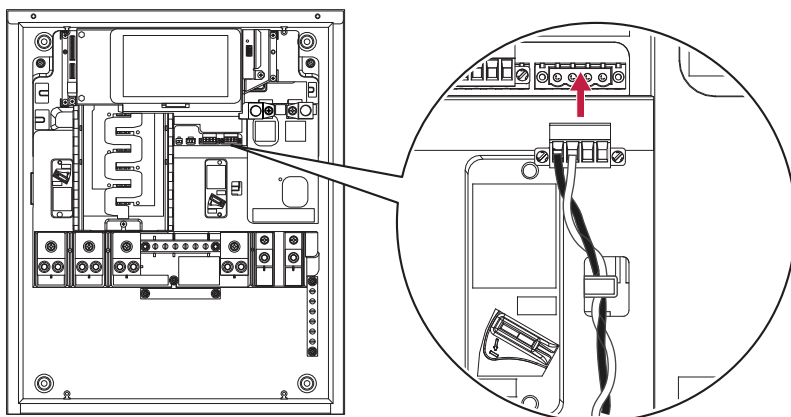

- 5 Connect the PV inverter conductors (L1, L2, Neutral, and Ground) to the corresponding terminals as shown in the figure.
- Fasten the PV CT to the PV L1 cable using a cable tie or other method.
- Arrange the power cables between the plastic case and metal enclosure and fasten them at the point indicated by the arrow using a cable tie.

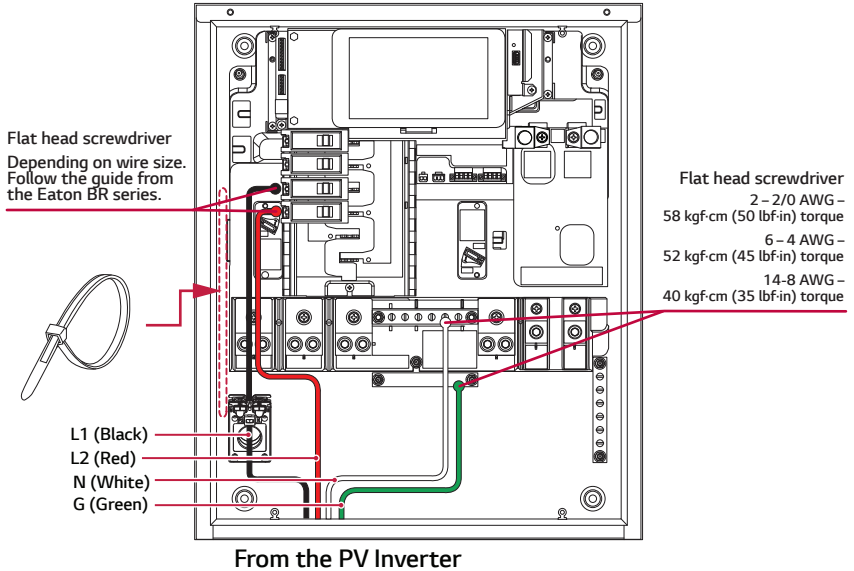

INFO

- Refer to "SE Box Wiring: Current Transformer (CT)" for additional diagrams on configuring energy metering.
- Refer to "SE Box Wiring: Current Transformer (CT)" for CT configuration troubleshooting tips.

Internet Connection

Internet connection and a ThinQ service subscription are required for the 10-year limited warranty and to view the system status in the LG ThinQ® App.



INFO

- Connect the ethernet cable first, then connect the communication cable.

Ethernet Connection

- Ethernet cable must be CAT5 UTP(24 AWG) or better.
- If it is not possible to run an Ethernet cable directly to the customer's network router, a Powerline Ethernet socket adapter may be used.
- Fix the cable to the lower hook as shown in the figure. Arrange the cable between the plastic case and metal enclosure.

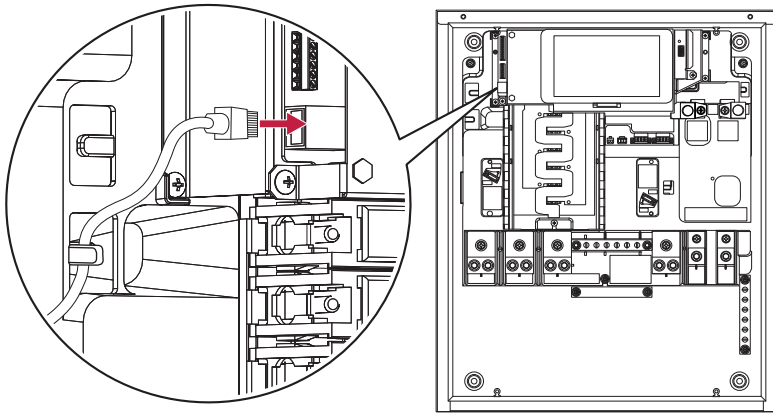

External Shutdown Switch Installation (If Required)

WARNING

- Before making a connection on the shutdown switch, you must ensure disconnection from the Home 8, Grid, and other power sources. It may cause death or serious injury due to electric shock.
- Conduit fittings (hubs) are required for all installations. NEMA Type 3R conduit fittings (hubs) are required when installing outdoors. (One for each used conduit opening)
- Before working with a hole saw, clear a space in the conduit area. It may cause damage to cables.

INFO

This section provides guidelines on system functionality. Please consult your local AHJ or Utility before use.

The External Shutdown Switch is wired through a low voltage, 12 V DC, control circuit connected to a SE Box AUX/Comms port.

- 1 Using at least 24 AWG conductors (maximum 16 AWG) with wiring methods according to code, connect pin 5 and 6 (labelled "STOP_P" and "STOP_N") to a compatible shutdown switch.

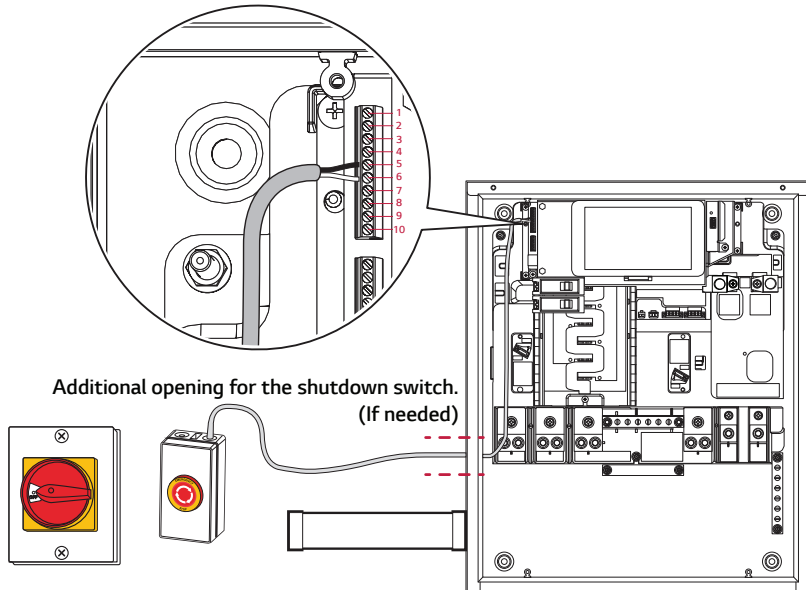

- 2 Confirm that all Home 8 operation is shut down when the switch is pressed with a plunger type switch or OFF position with the rotary type switch.

External Shutdown Switch Requirements

- Must be listed or recognized as an "Emergency Stop Button," "Emergency Stop Device," or an "Emergency Stop Unit."
- Must have an ON/OFF position.
- Must have a clear ON/OFF position indicator.
- Must be rated for outdoor use. (NEMA 3R or higher)
- Should be installed externally in a readily accessible location, preferably by the utility meter.
- The maximum length of the low voltage wire running from the switch to the SE Box should not exceed 300 feet (90 m).
- Should observe 12V, 0.1A ratings.

Please consider a switch or contact type when preparing the external shutdown switch.

Switch Type	Contact Type	System Energized	System Shutdown
Rotary Switch	Short in ON position	ON position	OFF position
Plunger Type (Mushroom)	NC (Normally Closed) Short released	Released	Pressed

External Shutdown Switch Operation

The External Shutdown Switch option must be enabled on the HMI screen in order to use it. Please ensure that this function is operating normally after the installation.

If it is enabled, the external shutdown switch will make the system operate as stated in the following table.

Shutdown Switch		Home 8 Operation
Plunger Type (Mushroom)	Rotary Type	
Pressed	OFF position	All Home 8 operations will be shut down (The Home 8 will be in standby mode with no AC voltage output). This operation is the same regardless of AC grid presence.
Released	ON Position	[AC grid present] The system operation will resume normally soon.
		[AC Grid not present (Off-grid or AC grid is down)] Home 8 operation will only resume when the utility grid is recovered or when woken by "Black Start" on the Home 8.

- When Black Start operation is required, follow the guidelines for "Black Start".

Backup Load Connection

Available Backup Power

Maximum discharging power/current: 7.5kVA / 31.25A

Peak discharging power/current (for 10s): 9.0kVA / 37.5A

Considering the available backup power, please connect the loads to the backup panel.

After the installation, please check whether the LG ESS Home 8 can provide backup power properly in "Backup Testing Guidelines".

- The backup load will be supplied by the LG ESS Home 8 and PV during a power outage.
- The non-backup load will power down during a power outage.

Backup Load Considerations

The backup power is a limited power source stored in the battery system. Depending on the load types, the stored energy in the battery may be drained rapidly or the system may restart due to big load changes (likely due to the inrush current), or the system may be shut down to protect the battery and the whole system. Please be careful to use the battery system in backup operation by referring to the following table.

Classification	Types of Loads
General appliance	Small plug-in appliance such as TVs, Laptops/PCs, Radios, Routers, and Mobile chargers Lightings (Compact fluorescent or LED recommended) Refrigerator and freezers. Small kitchen appliances (Coffee makers, Cookers, Microwaves)
Large load	AWHP (Air to water heat pumps) / Electric water heaters Electric cooktops / Electric ovens Spas / Saunas Washers / Dryers Hair Dryers EV Chargers
High inrush load	Air conditioners Pool pump, Well pump, Sump pump

- Do not use loads exceeding the maximum power or current in the backup load, which may shut down the whole system.
- Using a large load can rapidly drain the battery.
- For a high inrush load, please use the soft starter to consider the LRA spec on the labels from the loads. Depending on the base power consumed for backup operation, the available supply to the inrush current from the LG ESS Home 8 may vary.
- When using an air conditioner, it is especially important to perform a backup test. If the system frequently restarts, use a soft-starter for the air conditioning unit.
- The application is subject to change for appliance improvement purposes without notice.

Backup Testing Guidelines

After the installation, please check whether the LG ESS Home 8 can provide backup power properly through the following steps.

* LG ESS Home 8 provides the seamless transition within 100ms.

- 1** Run the LG ESS Home 8 and make sure the system operates and is not set to "STOP".
- 2** To prevent a system malfunction caused by the backup PV inverter, please leave the PV circuit breaker in the OFF position during this step.
- 3** Simulate a power outage by turning off the dedicated breaker of the SE Box or the Service Disconnect Switch.
 - If you turn off the service disconnect switch, the non-backup loads will be powered down.
 - If you turn off the dedicated circuit breaker of the SE Box, the non-backup loads will be still powered by the utility grid in the partial backup system.
- 4** Check that the LG ESS Home 8 provides backup power without any faults or errors. If there were any faults or errors, LG ESS Home 8 will automatically restart within 10 minutes. It may generally take 2 minutes for a single ESS installation. If the system does not restart within 10 minutes, please turn on the dedicated breaker of the SE Box or the Service Disconnect Switch and check the event history.
- 5** If it works normally, please connect the system to the grid connection by turning on the dedicated breaker of the SE Box or the Service Disconnect Switch for the grid recovery. It will take around 1 minute.
- 6** Check that the system operates with the grid connection.
- 7** Turn on the PV circuit breaker and check the PV generation on the HMI screen.
- 8** After the PV generation, simulate a power outage again.
- 9** In the beginning of the backup, the LG ESS Home 8 system shifts AC frequency to block the PV generation for a stable transition to backup operation. Please check that the PV generation stopped at the start of the backup operation, and then wait at least 5-8 minutes for PV generation, depending on the grid profile of the PV inverters.
- 10** Check that the PV generation and LG ESS Home 8 operate well. Depending on the PV generation power and the backup load consumption, the LG ESS Home 8 will be charged or discharged to the backup load.
- 11** If there were no problems, turn on the dedicated breaker of the SE Box or the Service Disconnect Switch for grid recovery. It will take about 1 minute.
- 12** Check that the system operates well with the grid connection.

Backup Test Troubleshooting Guide

If you have any problems in testing the backup, please read the following carefully.

Please connect the system to the utility grid to check the system status.

Please check the event history during the backup testing on the HMI screen: [Menu] > [Installer Settings] > [PCS Settings] > [Event history]

Check the opened and closed events. If you can find any fault related to over current (OC), the overloaded, or over power faults in the history, please check the load connection and the types of loads.

1. Air conditioners

If the air conditioner was connected to the backup load, please perform backup testing without the air-conditioner connected. Please turn off the air-conditioner circuit breaker and then do a backup testing again. If the system operates well, a soft-starter should be installed for the air conditioner.

2. Pumps (Well pumps, Sump pumps, Pool pumps, etc.)

If the pumps were connected to the backup load, please check it through the same method as listed for the air conditioner backup testing listed above.

If the air conditioner or pumps are not used in the backup load, check the load consumption power in backup and check the ambient temperature around the Home 8 unit. The output power may be de-rated by the temperature to protect the battery units.

If the situation above does not apply, please check the power connection and the polarity of the power cables in the system. Make sure the same polarity is used for multiple Home 8 installation.

If the system is still not working well, please contact to a service professional.

Installation Completion

- 1 Before closing any installed hardware, take photos of the completed wiring in the SE Box, Home 8, and main panel.
- 2 Make sure that all conduit junctions and cable entry points are secure and properly sealed.
- 3 Arrange the communication and AC power wires neatly inside the Home 8 wiring compartment.
- 4 Install the SE Box safety cover and secure it firmly with the original screws.
Before attaching the safety cover to the SE Box, remove the panels on the circuit breaker installed positions. When removing the panels, make sure the burr parts in each panel hole are cleanly removed.

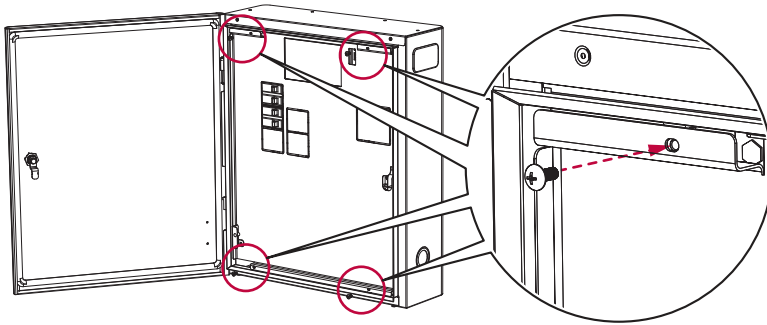

CAUTION

The labels and markings must comply with the NEC and local code. The corresponding labels must be attached after the installation inspection has been approved by AHJ.

- 5 Attach naming labels to distinguish the breakers.

CAUTION

High voltage is energized through the internal battery module and wiring. Special care must be taken.

- 6 Switch the battery circuit breaker on the Home 8 to the ON position and close the front cover.

When closing the front cover, make sure the front cover is securely fitted to the gasket for a proper waterproof seal.

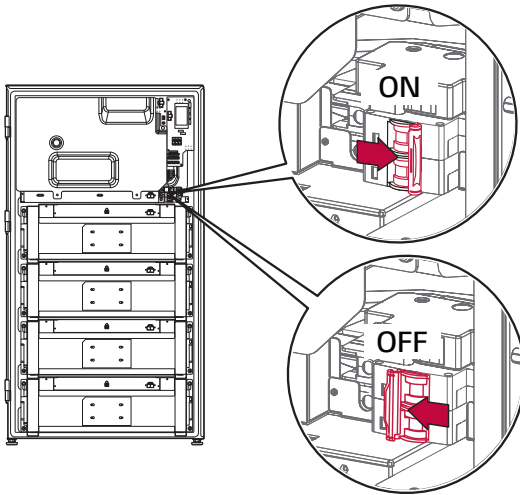
**CAUTION**

Make sure the door is correctly closed and all bolts are fastened. Otherwise, the NEMA 3R grade cannot be maintained.

- 7 Fasten the screws on the right side of the Home 8. (25 kgf·cm (22 lbf·in) torque, Hex socket : M8)

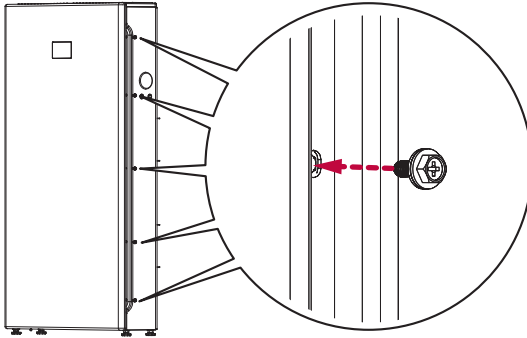

INFO

The main circuit breaker for the SE Box should be installed in the SE Box or upstream of the SE Box.

- 8 Switch the main circuit breaker for the SE Box to the ON position and wait until the main screen appears on the HMI display. It will take about 30 seconds.
- 9 Switch the circuit breaker for the Home 8 to the ON position.
- 10 Switch the circuit breaker for the PV inverter to the ON position (if equipped).
- 11 Press the POWER button and press and hold the BLACK START (6s) button for at least 6 seconds until you hear a "click."
If the SoC level is shown on the LED display of the Home 8, the booting process has been completed normally.

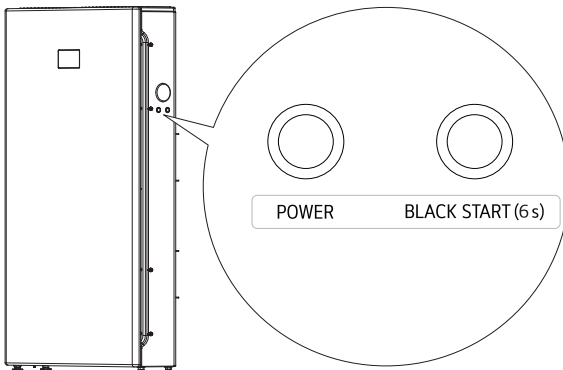

CAUTION

All covers must be correctly reassembled. Otherwise, the NEMA 3R grade cannot be maintained.

- 12** Close and lock the front door using an 8 mm (5/16 inch) hex wrench.
When closing the SE Box front door, check the direction of the locking rack. If the direction of the locking rack is not correct, the door will not close properly.

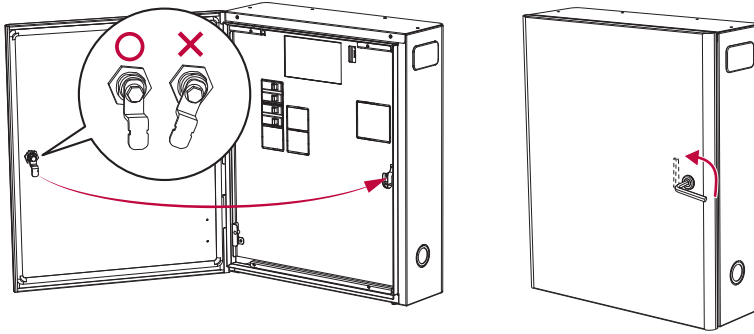

- 13** Set all of the system settings on the HMI display of the SE Box and start commissioning.

Wiring Reference

Home 8 Wiring

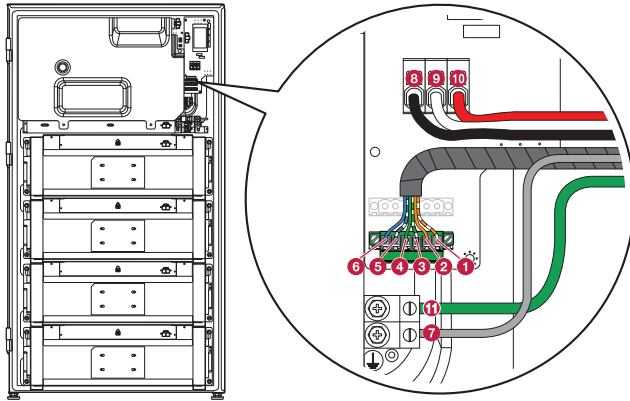

No.	Home 8 Terminals	Recommended Wire Color	Wire Gauge
1	CAN + (CAN HI)	Orange-White (CAT 5E STP)	24 – 16 AWG
2	CAN - (CAN LOW)	Orange (CAT 5E STP)	24 – 16 AWG
3	12V	Green-White (CAT 5E STP)	24 – 16 AWG
4	RELAY CHECK	Green (CAT 5E STP)	24 – 16 AWG
5	GRID CHECK (LOGIC)	Blue-White (CAT 5E STP)	24 – 16 AWG
6	GND	Blue (CAT 5E STP)	24 – 16 AWG
7	Cable Shield/Drain Wire	(Terminate at the Home 8 chassis ground lug only)	
8	L1 (Line 1)	Black	6 – 4 AWG
9	N (Neutral)	White	6 – 4 AWG
10	L2 (Line2)	Red	6 – 4 AWG
11	Chassis Ground Lug	Green / Yellow	8 – 6 AWG

- Depending on the local code for installation methods and cable sizing calculations.
- If a communication cable may use cable types other than CAT 5E STP, follow the twisted pair correctly.
Twisted-pair: CAN HI - CAN LOW / 12V - RELAY CHECK / GRID CHECK - GND

INFO

- Refer to local codes and standards for correct wiring practices and colors.
- Suitable wire ferrules may be used for power terminals, but are not required.

SE Box Wiring: Power

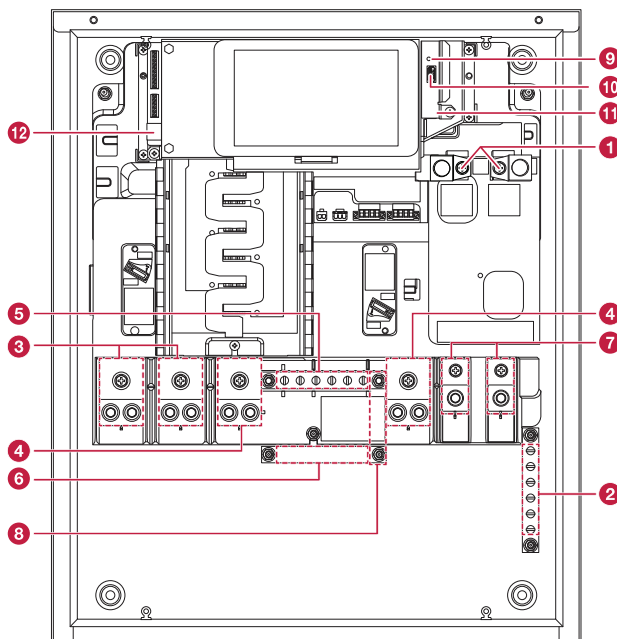

No.	Home 8 Terminals	Recommended Wire Color	Wire Gauge
1	Grid Terminal (L1,L2)	Black, Red	6 AWG – 300 kcmil
2	Ground Terminal (Grid, Load) - 6 Positions	Green, Bare	14 AWG – 2/0 AWG
3	Backup Load Terminal (L1,L2)	Black, Red	6 AWG – 250 kcmil
4	Neutral Terminals (Grid, Load)	White	6 AWG – 250 kcmil
5	Neutral Terminals (Home 8, PV Inverter)	White	14 AWG – 2/0 AWG
6	Ground Terminal (Home 8, PV Inverter) – 6 positions	Green, Bare	14 AWG – 2/0 AWG
7	Non-Backup Load Terminals (L1,L2)	Black, Red	6 AWG – 250 kcmil
8	N-GND Bonding Busbar	Included with the SE Box	45 mm ²
9	RESET Button	-	-
10	USB Connector	-	-
11	DRM Connector	-	(Optional)
12	Ethernet Connector	-	24 AWG CAT5 or better

* Use copper or aluminum conductors rated at 90 °C (194 °F).

SE Box Wiring: Internal Panelboard

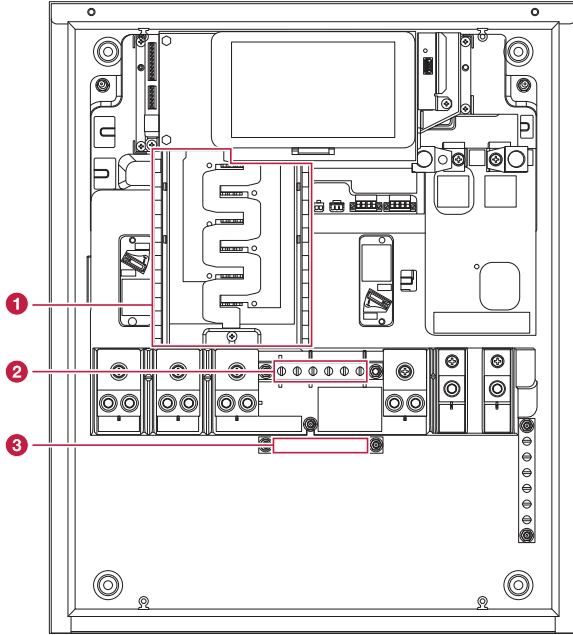

The internal Panelboard is 200A-rated and supports 5 x 2-pole breaker spaces (10 circuits) using Eaton BR Branch circuit breakers up to 125 A.

If an external generation panel is required for a large PV and Home 8 system, use a sub-feed lug (Eaton, BRS225 / BRPSF225) on the internal panel board. In this case, other spaces on the internal panelboard can not be used for the circuit breaker. Leave no breakers.

The Home 8 connection to the SE Box always requires a 40 A Circuit breaker. This breaker serves as circuit protection for the Home 8.

Breaker sizing, connection, and installation must comply with the National Electric Code.

For more information, please refer to "Internal Panelboard and Additional Fastener".

No.	Terminals	Recommended Wire Color	Wire Gauge
1	BR Series Circuit Breaker on the Internal Panel Board	L1 : Black, L2 : Red	Depends on the breaker sizing
2	Neutral Terminal (Home 8, PV Inverter) – 6 Positions	Green, Bare	8 – 6 AWG
3	Ground Terminal (Home 8, PV Inverter) – 6 Positions	Green, Bare	8 – 6 AWG

* Use copper or aluminum conductors rated at 90 °C (194 °F).

SE Box Wiring: Communication

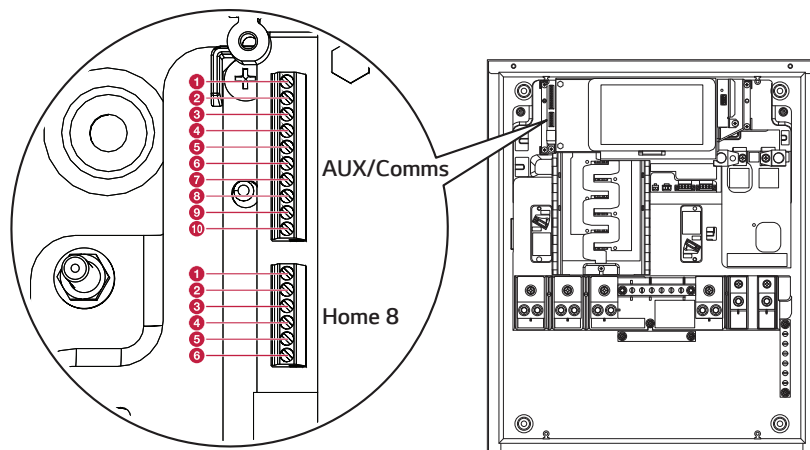

AUX/Comms

No.	Terminals	Recommended Wire Color	Wire Gauge
1	RS485 #1 B (LOW)	Black	24 - 16 AWG
2	RS485 #1 A (HIGH)	Red	24 - 16 AWG
3	RS485 #2 B (LOW)	Black	24 - 16 AWG
4	RS485 #2 A (HIGH)	Red	24 - 16 AWG
5	STOP_P	Black	18 - 16 AWG
6	STOP_N	White	18 - 16 AWG
7	AUX1_P	Black	18 - 16 AWG
8	AUX1_N	White	18 - 16 AWG
9	AUX2_P	Black	18 - 16 AWG
10	AUX2_N	White	18 - 16 AWG

Home 8

No.	Terminals	Recommended Wire Color	Wire Gauge
1	CAN + (CAN HI)	Orange-White (CAT 5E STP)	24 - 16 AWG
2	CAN + (CAN LOW)	Orange (CAT 5E STP)	24 - 16 AWG
3	12V	Green-White (CAT 5E STP)	24 - 16 AWG
4	RELAY CHECK	Green (CAT 5E STP)	24 - 16 AWG
5	GRID CHECK (LOGIC)	Blue-White (CAT 5E STP)	24 - 16 AWG
6	GND	Blue (CAT 5E STP)	24 - 16 AWG

SE Box Wiring: Current Transformer (CT)

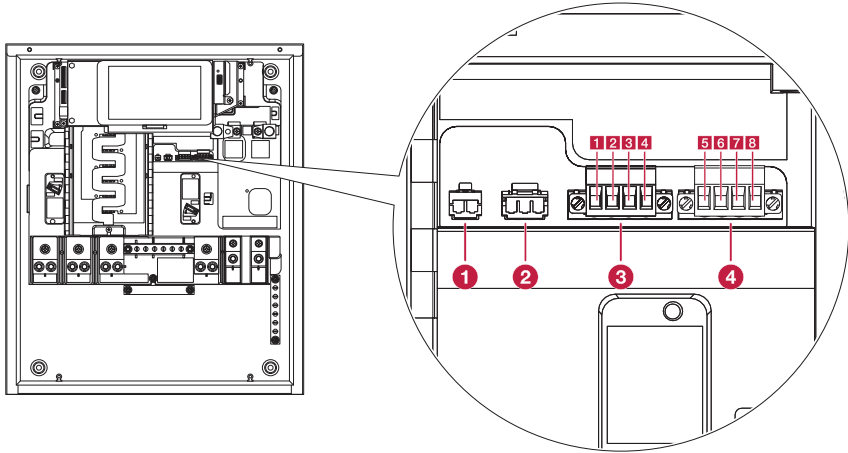

- 1 Internal site net metering CT cable (L1)
- 2 Internal site net metering CT cable (L2)
- 3 External site net metering CT connector (L1,L2)
- 4 PV Generation metering CT connector (two L1)

Home 8 SE Box Wiring : External Site Net Metering CT Connector

No.	Terminals	Recommended Wire Color	Wire Gauge
1	Ext. site net CT L1 +	Black	18 – 14 AWG
2	Ext. site net CT L1 -	White	18 – 14 AWG
3	Ext. site net CT L2 +	Red or Black	18 – 14 AWG
4	Ext. site net CT L2 -	White	18 – 14 AWG

- If external site net metering CTs are required, refer to "Usage of External CTs" for the exact wiring requirements for external site net metering.

Home 8 SE Box Wiring PV Generation Metering CT Connector

No.	Terminals	Recommended Wire Color	Wire Gauge
5	PV CT L1 +	Black	18 – 14 AWG
6	PV CT L1 -	White	18 – 14 AWG
7	PV CT L1 +	Black	18 – 14 AWG
8	PV CT L1 -	White	18 – 14 AWG

- Pin 1 and Pin 3, Pin 2 and Pin 4 are shorted inside of the circuitry. All pins may be used for multiple CTs for PV generation if required. If only 1 CT is used in the system, please use pins 1-2 or pins 3-4.
- Twisted cable may improve the CT measuring. If an extended cable is required, please twist.

Extending CT Cable Length

A CT cable (1.5 m) is included in the SE Box package for PV generation metering. The ring terminals are required for additional CT connections. (Insulated type is recommended.) The stud size is 1/4 inch (M6) and the required wire range is 18 AWG. A suitable crimp tool is required.

When extending the wire is required, the installer should prepare the cable following this guidance.

Most of the CT cable noise will be line noise (50 or 60 Hz). Since this noise generates at the same frequency as the signal measured by CT, induced noise may affect the accuracy of current measurements, especially at a low current level.

General Guidelines

- Keep the cables as short as possible.
- Route the CT cables through a dedicated conduit.
- Do not route CT cables through the same conduit as the voltage cables.
- Keep as far away as possible from other power cables, VFDs (Variable Frequency Drives), and other heavy machinery.
- Do not run cables in parallel with other power cables.

Specific guidelines and requirements.

- Use the same wire type and gauge to match that of the CTs. (The provided CT cable uses UL1015, 18 AWG.)
- The extension cable pair must be twisted (about one twist per inch). The twisted cable increases the cable's differential immunity to induced noise at line frequency (50 or 60 Hz). The direction of the twisting should be same as the provided or existing twisted cables.
- Avoid large open loops in the cable at the joint – Maintain the twisting until as close to the joint as possible.
- The best ways to create the electrical connection at the joint:
 - The best way to join the wires is a solder joint covered and insulated with heat shrink tubing. Alternately, the provided cable can be switched out for a new, longer cable suitable for the long distance CT.
 - Wago 221 Series Lever Nuts (TWO 2-pole lever nuts are required for 1 CT.)
 - Crimp-On Butt Splice (insulated type). These require a special crimping tool, so this method is not always practical.
 - Do not use normal electrical wire nuts, as these do not provide a good electrical or mechanical connection with 18 AWG wire.
 - Do not simply twist the bare wires together.

Installer Setup Wizard

When this product is turned on for the first time, the installer setup wizard may be used by an authorized service personnel.

Before starting the SE Box settings, the physical connection and installation must be securely done exactly as described in this manual.

 **INFO**

- Touch operation may not be possible when wearing gloves.
- Touch operation may not work if your fingers are wet or sweaty.

Step 1: Country And Language Settings

You can choose the country and language to use for the system settings.

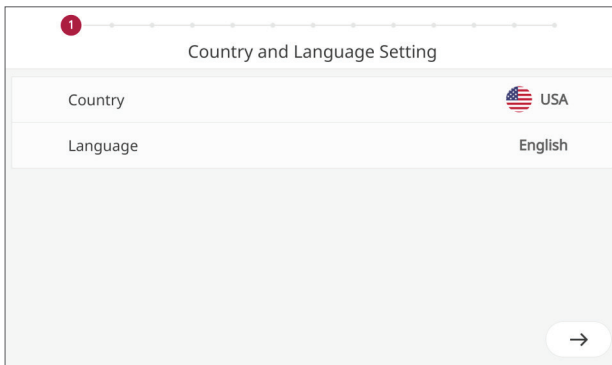

[Country]: Press the currently selected country and select the desired country from the list.

[Language]: Press the currently selected language and select the desired language to change.

Step 2: Network Type

You can choose the network settings for the system. Refer to "Network Settings" for more information.

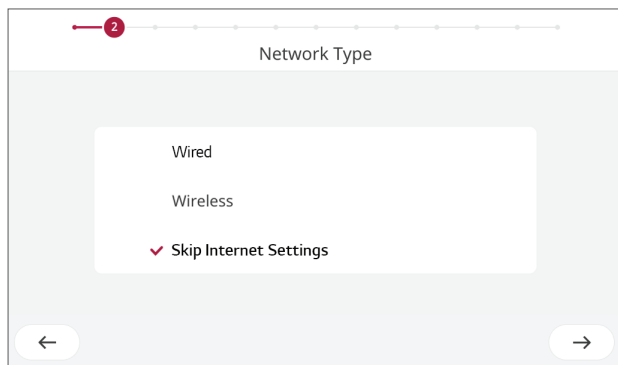

Wired

If the network is connected by an ethernet cable, select [Wired] in the [Network Type] wizard.

Wireless

If you want to use the wireless network connection, select [Wireless] in the [Network Type] wizard.

Skip Internet Settings

If you do not want to connect the system to the internet, select [Skip Internet Settings] in the [Network Type] wizard.

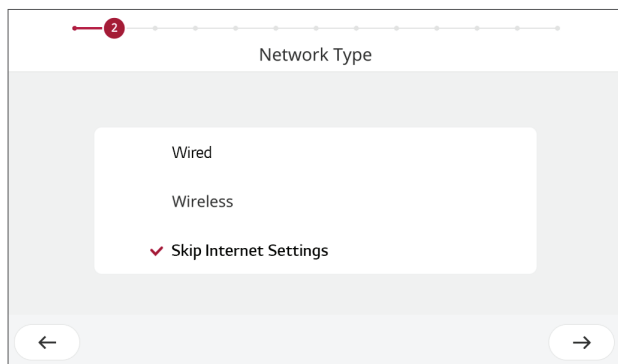

If the system is not connected to the internet, the installer cannot monitor the system status through the web monitoring system or mobile app.

Step 3: Installer Password Setting

You can set a password for accessing the system display.

Press the [Input password] field and input the desired password.

Your password must be at least 8 characters long. The password must contain at least one number, one special character, and one letter.

Press the [Confirm Password] field and input your password again, then press [Apply] to set the password.

Step 4: System Information

You can check the system information.

Check that the loaded system information is correct. If it is not, check the DIP switches on each Home 8 and press [Rescan] to retrieve the information.

Refer to step **[9]** of the "Wiring Connection between the SE Box and Home 8" for DIP switch settings.

For multiple connections, see "Multiple Connection ID Setup Method".

Step 5: Firmware Update

You can update the firmware of the system to the latest version via USB .

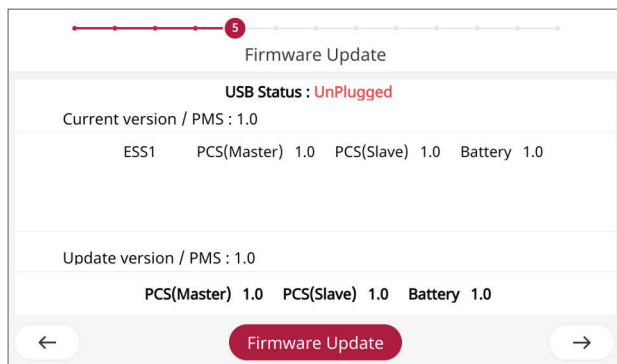

The current version and new version of the system firmware are displayed. Connect a USB storage device containing the latest software to the USB connector and press [Firmware update] to start the firmware update.

Step 6: Date & Time Settings

You can set the current date and time. Refer to "Date & Time Settings" for more information.

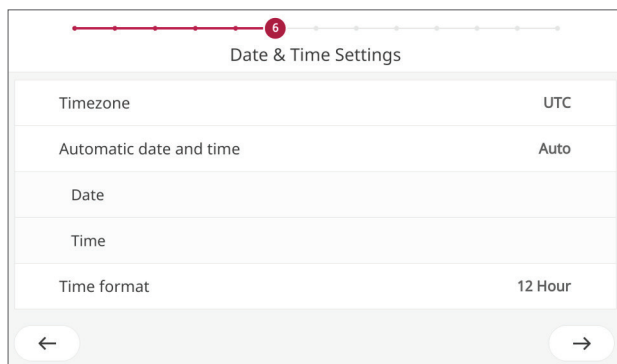

Step 7: Additional System Information

You can input the system name and installation date.

Additional System Information	
System Name	My ESS
Installation Date	Mar 13, 2022

Step 8: Utility Information

You can set up a communication connection with utility company and grid profile.

Utility Information	
Utility Company	
Grid Profile	IEEE1547
Config Parameters	Edit >

Utility Company

Input the name of a utility company.

Grid Profile

Select the appropriate grid profile option for the system environment.
Select the grid profile at your location.

Config Parameters

Set the config parameters of the selected grid profile. The available config parameters are displayed when you click the "Edit" button.

- Table of field adjustable trip limits for voltage and frequency

Category	Region		Unit	IEEE1547			CA Rule21		
				Default (as shipped)	Min	Max	Default	Min	Max
AC Voltage (% of Nominal Voltage)	OV Level1	Voltage Range	%	110	110	120	110	110	120
		Trip Time Range	sec	13	1	13	13	1	13
	UV Level1	Voltage Range	%	88	0	88	88	50	88
		Trip Time Range	sec	21	21	50	21	21	50
	OV Level2	Voltage Range	%	120	-	-	120	-	-
		Trip Time Range	sec	0.16	-	-	0.16	-	-
	UV Level2	Voltage Range	%	50	0	50	50	-	-
		Trip Time Range	sec	2	2	21	1.5	0.5	21
	UV Level3	Voltage Range	%	50	0	50	50	-	-
		Trip Time Range	sec	2	2	21	1.5	0.5	21
Frequency	HF Level1	Frequency Range	Hz	61.2	61	66	60.5	60.1	66
		Trip Time Range	sec	300	180	1000	300	0.16	1000
	LF Level1	Frequency Range	Hz	58.5	50	59	58.5	57	59.9
		Trip Time Range	sec	300	180	1000	300	0.16	1000
	HF Level2	Frequency Range	Hz	62	61.8	66	62	62	64
		Trip Time Range	sec	0.16	0.16	1000	0.16	0.16	1000
	LF Level2	Frequency Range	Hz	56.5	50	57	57	53	57
		Trip Time Range	sec	0.16	0.16	1000	0.16	0.16	1000

Step 9: PV

You can check the information for the PV inverter that is connected to the system.

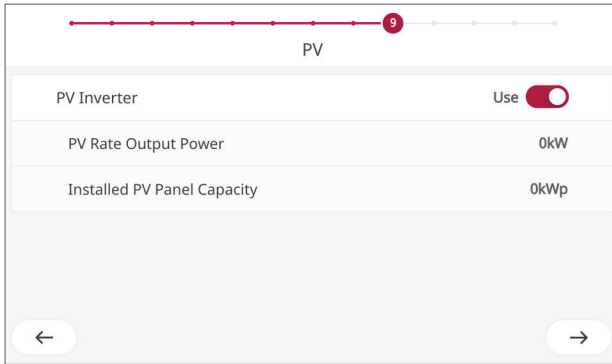

If you are using a PV inverter, set this option to [Use] and fill the [PV Rate Output Power] and [Installed PV Panel Capacity] fields.

Step 10: External Device

If you are using an external shutdown switch, set the [External Shutdown Switch] option to [Installed].

You can check the device that are connected to port 1 and port 2. If no devices are connected to the ports, it will display as [None].

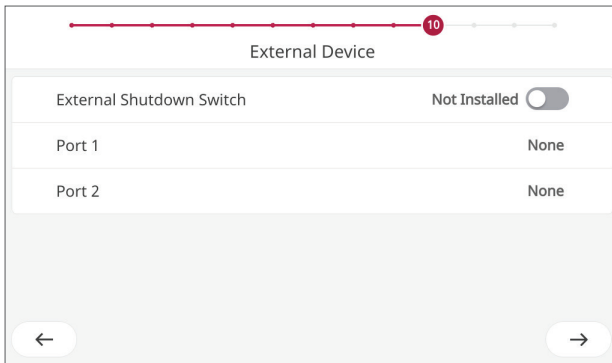

Step 11: Operating Mode

You can select an operating mode. Refer to "Operating Mode" for more information.

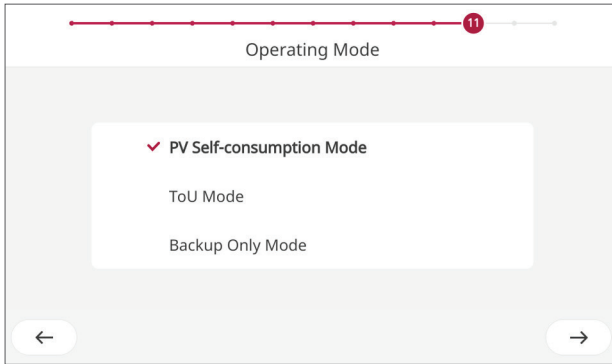

Step 12: Battery Settings

You can set the battery's reserve SoC level in case of a power outage. The default level is set to 20%.

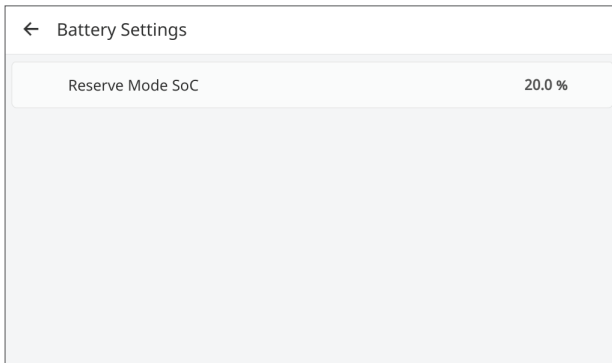

Step 13: Summary

This is the last stage of the settings. Before operating the system, check all of the settings on the [Summary] display. Before operating the system, running a [Commissioning Test] is a way to verify that the system has been set up correctly. If it is not possible to run a [Commissioning Test], select [Start System] to launch the system.

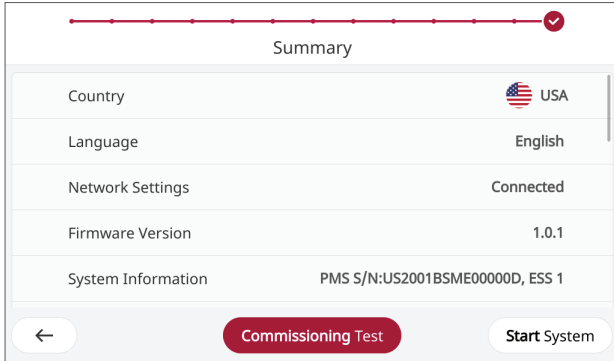

About the HOME Screen

The HOME screen displays and indicates the current system status. You can also check several settings and other information on the HOME screen.

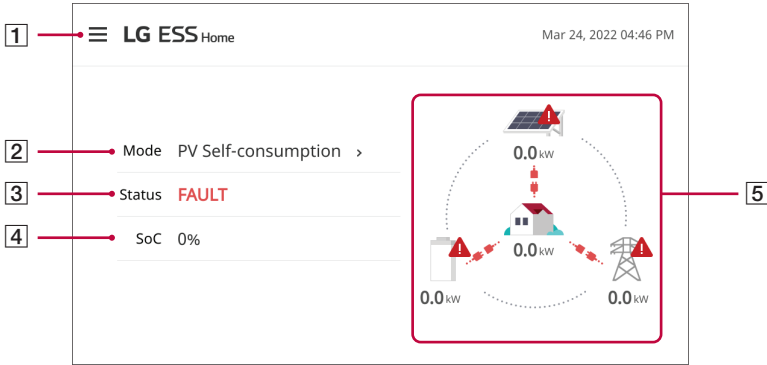

- 1 Displays the sub-menu.
- 2 Displays the currently running mode.
- 3 Displays the system status. (Waiting, Charging, Discharging, Warning, Fault, Standby, Stop, Disconnected, or Force Stop)
- 4 Displays the charge status of the battery.
- 5 You can check the power flow and error messages for the PV, Battery, Grid, and Home load.



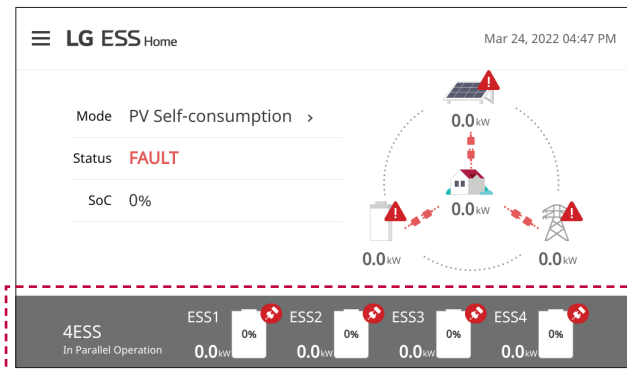



If there are 2 or more Home 8 units installed in the system, each Home 8's status and error messages are displayed on the HOME screen as shown below.

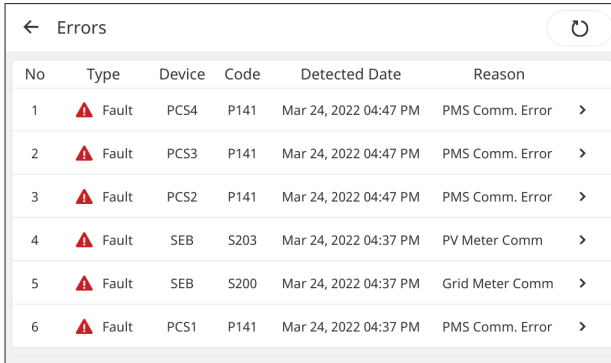

Errors

If an error occurs in the SE Box or Home 8, the current error information is displayed in the Event History. Press  to show the errors.



No	Type	Device	Code	Detected Date	Reason	
1	 Fault	PCS4	P141	Mar 24, 2022 04:47 PM	PMS Comm. Error	>
2	 Fault	PCS3	P141	Mar 24, 2022 04:47 PM	PMS Comm. Error	>
3	 Fault	PCS2	P141	Mar 24, 2022 04:47 PM	PMS Comm. Error	>
4	 Fault	SEB	S203	Mar 24, 2022 04:37 PM	PV Meter Comm	>
5	 Fault	SEB	S200	Mar 24, 2022 04:37 PM	Grid Meter Comm	>
6	 Fault	PCS1	P141	Mar 24, 2022 04:37 PM	PMS Comm. Error	>

[Type] shows the severity of the error, [Device] shows the information of the device where the error occurred, and [Code] shows the error code.

Backup History

If the system is in backup mode due to a power outage, you can check the time when the backup started, the time the power outage ended, and how long the power outage was maintained.

Press  > [Backup History] to show the event history.

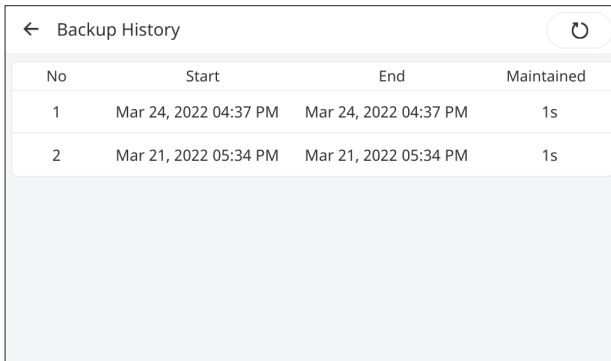

No	Start	End	Maintained
1	Mar 24, 2022 04:37 PM	Mar 24, 2022 04:37 PM	1s
2	Mar 21, 2022 05:34 PM	Mar 21, 2022 05:34 PM	1s

Installer and User Settings

The installer or user may need to change the system settings, even if all of the settings were set when the system was initially installed.

Press **[≡]** to enter either the [User] or [Installer] settings menu.

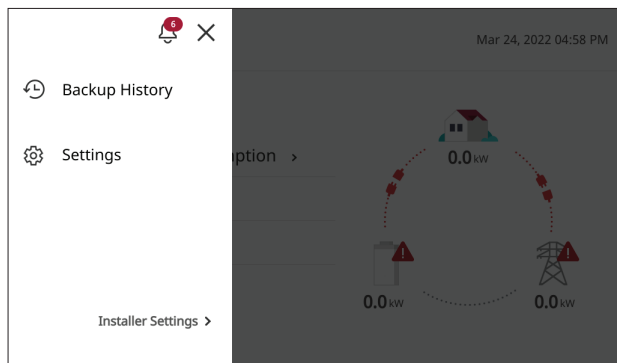

To enter the Installer settings menu, you need to input the password on the screen.

Input the password to enter the settings menu.

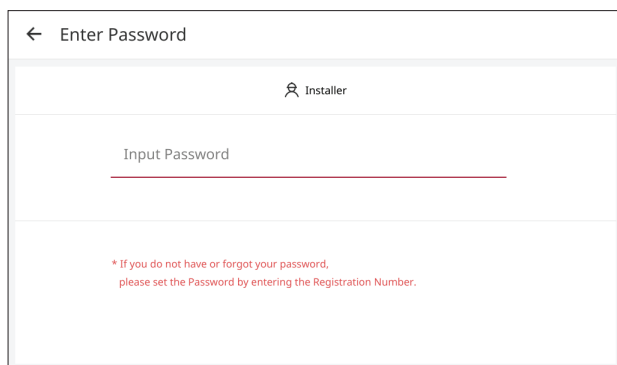

If you input the incorrect password 5 times, you cannot attempt to input another password for one minute.

General Settings

Country

Press the currently selected country and select the desired country to change.

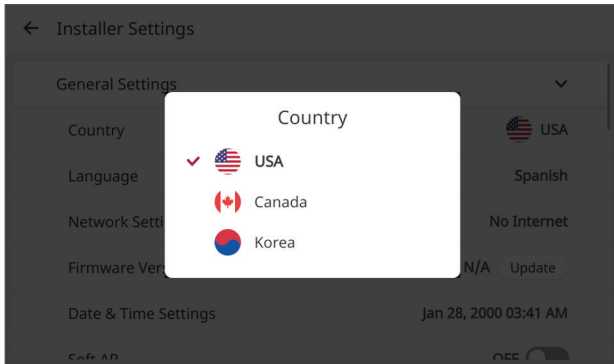

Language

Press the currently selected language and select the desired language to change.

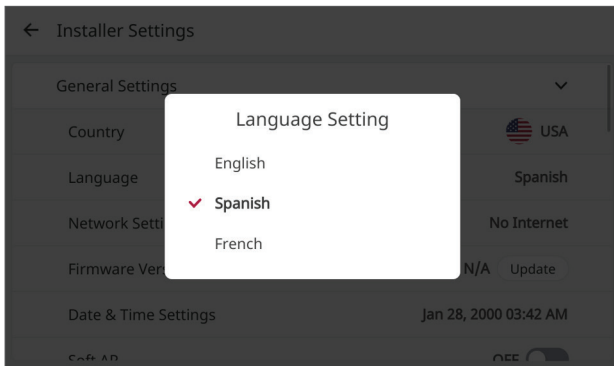

Network Settings

You can choose the network setting for the system. Select the connection type, either [Wired] or [Wireless].

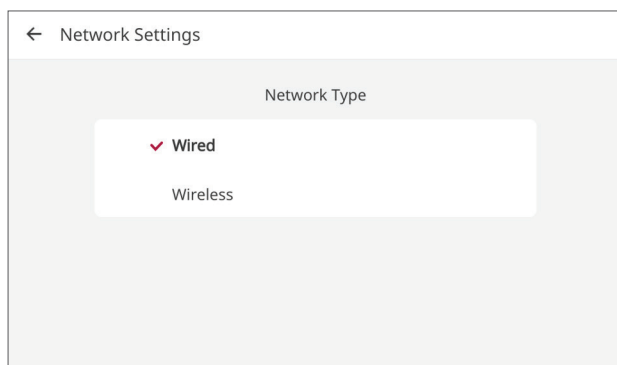

Wired

If the network is connected by an ethernet cable, select [Wired] on the [Network Settings] screen.

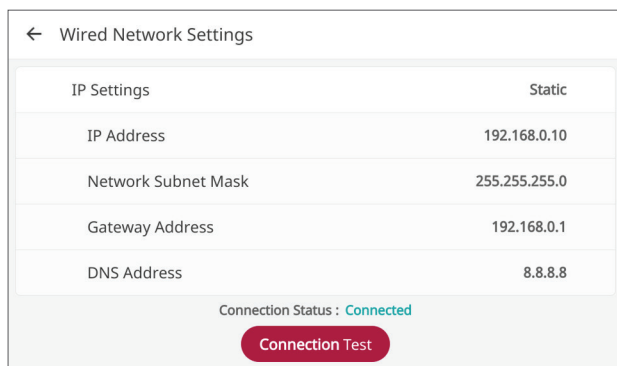

If the [IP Settings] option is set to [DHCP], the system will automatically be allocated an IP address from the local area network (LAN) through the wired connection. You may need to set the network connection manually depending on the network conditions. In this case, press [DHCP] to change to [Static].

If you set the [IP Settings] option to [Static], fill in the [IP address], [Network Subnet Mask], [Gateway Address] and [DNS Address] options manually and press [Apply] to apply the network settings.

Wireless

If you want to use a wireless network connection, select [Wireless] on the [Network Settings] screen. Available SSIDs are listed on the screen.

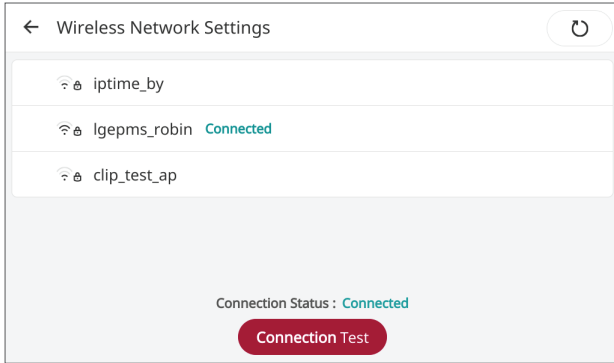

Select a SSID you would like to connect the system on the SSID list.

Input password of the SSID in the [Password] field.

After entering all the fields, tab [Connect] to finish the wireless network connection.

LG SE Box provides both wired and wireless internet connection. Depending on the SE Box location and the router, the wireless signal may be too weak to connect to the internet. The HMI screen on the SE Box will display a warning sign as shown below if the wireless signal is too weak.

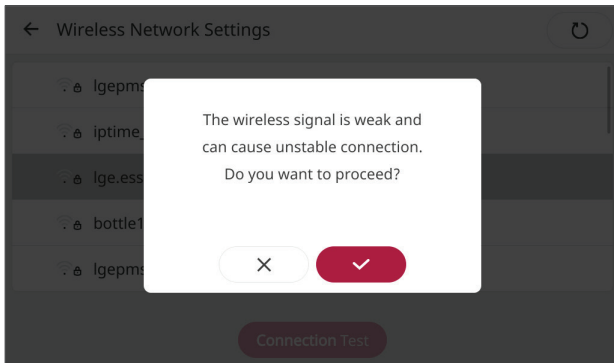

It is also necessary to check if the signal strength is sufficient under poor conditions (such as while the entrance or garage door is closed) during usage. If the signal is not strong enough to connect the internet, please consider installing the LG SE Box as close as possible to the router or install a WiFi range extender or Signal Booster.

 **INFO**

- Many network connection problems during set up can often be fixed by re-setting the router or modem. After connecting the product to the home network, quickly power off and/or disconnect the power cable of the home network router or cable modem. Then power on and/or connect the power cable again.
- Depending on the internet service provider (ISP), the number of devices that can receive internet service may be limited by the applicable terms of service. For details, contact your ISP.
- LGEUS is not responsible for any malfunction of this product and/or the internet connection feature due to communication errors/malfunctions associated with your broadband internet connection, or other connected equipment.
- Some internet connection operations may not be possible due to certain restrictions set by the Internet service provider (ISP) supplying your broadband Internet connection.
- A 10 Base-T or 100 Base-TX LAN port is required for wired connection to this product. If your internet service does not allow for such a connection, you will not be able to connect this product.
- A DSL modem is required to use DSL services and a cable modem is required to use cable modem services. Depending on the access method and subscriber agreement with your ISP, you may not be able to use the internet connection feature contained in this product or you may be limited to the number of devices you can connect at the same time. (If your ISP limits connection to one device, this product may not be allowed to connect when a PC has already been connected.)
- The use of a “Router” may not be allowed or its usage may be limited depending on the policies and restrictions of your ISP. For details, contact your ISP directly.
- Turn off all unused network equipment in your local home network. Some devices may generate network traffic.
- For the purpose of better wireless transmission, install the SE Box as close as possible to the access point.
- In some environments, placing the access point at least 0.45 m above the ground may improve the reception.
- When using a wireless network connection, remove all obstacles between the SE Box and the access point for better transmission.
- The reception quality over wireless depends on many factors such as type of the access point, distance between the SE Box and access point, and the location of the SE Box.

Firmware Version

You can check the current firmware version and update the firmware.

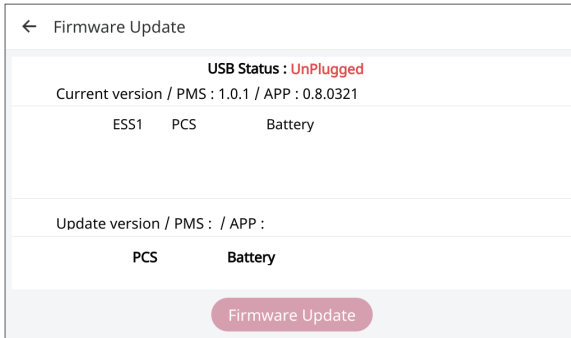

How to update the firmware.

Before updating the firmware, you need to store the latest firmware on a USB storage device and insert the USB storage device to the USB connector on the SE Box.

When the [USB Status] field displays [Plugged] on the screen, the firmware is ready to update.

Press [Firmware Update] to start the firmware update.

Date & Time Settings

You can set the current date and time.

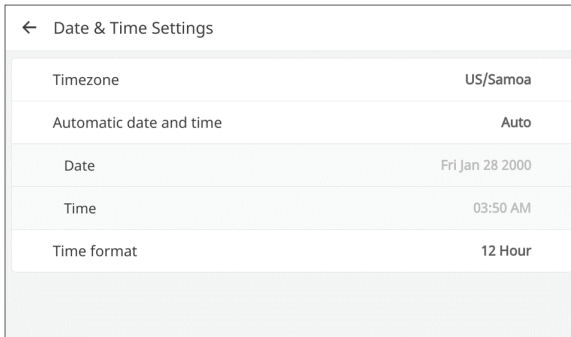

Timezone

Press [Timezone] and select the time zone for the region where the system is located.

Automatic date and time

If you set this option to [Auto], the date and time settings are automatically set through the internet.

Date / Time

You can set the date and time manually. Press [Date] or [Time] and set the current date and time.

Time format

Press [Time format] and select either [12 Hours] or [24 Hours].

Soft AP

The Soft AP (Software enabled Access Point) function provides a virtual AP function so that you can connect to the system through the LG ThinQ® App on a mobile device.

Press the ON/OFF switch to enable or disable this function.

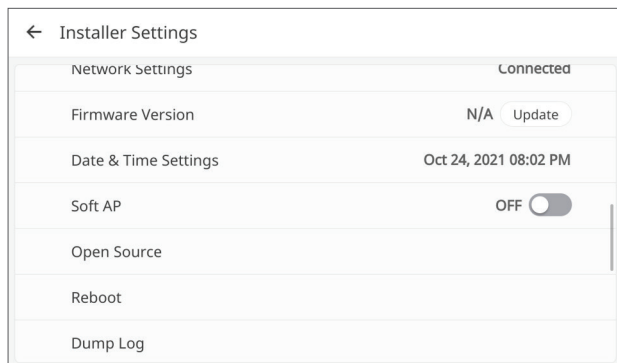

INFO

To use the Soft AP function, you need to register your system through the LG ThinQ® App. Refer to the LG ThinQ® App guide for detailed information.

Open Source

Press [Open Source] to see the Open Source Software Notice.

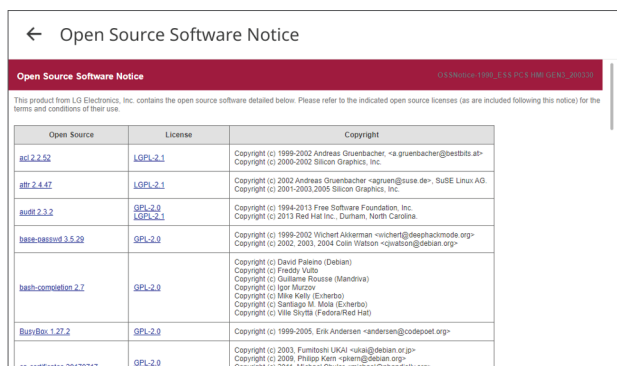

Reboot

Press [Reboot] to turn off and restart the system.

Dump Log (Installer Only)

The system stores the logs for the last 30 days. To download the log files from the system, you need to connect a USB storage device to the SE Box and tap [Dump Log] to download the log files to the USB storage device.

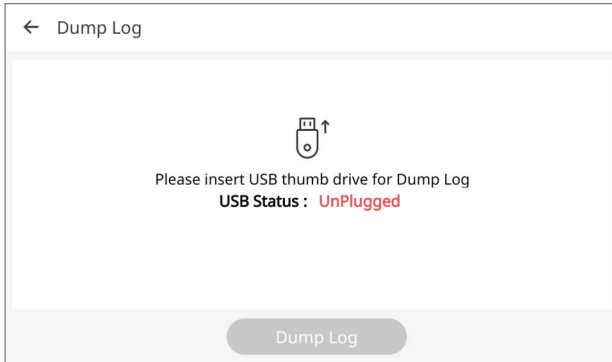

The current version and new version of the system firmware are displayed. Connect a USB storage device containing the latest software to the USB connector and Press [Firmware update] to start the firmware update.



INFO

- Only FAT32 formatted USB storage devices are able to download the logs.
- The log files are stored in a folder named the serial number of the system.

Factory Reset (Installer Only)

Press [Factory Reset] and select [Reset] in the pop-up to reset all of the settings to factory default.

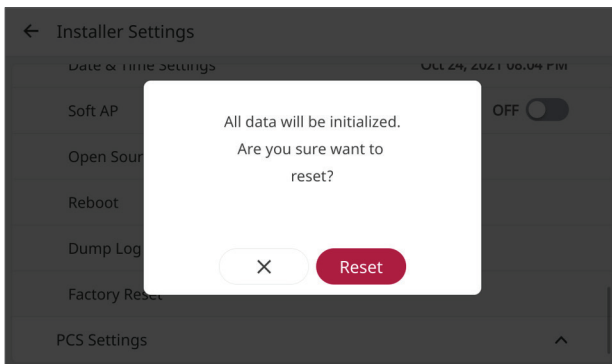

PCS Settings

Operation

Press the [Start/Stop] switch to enable or disable the system operation.

System Information

You can check the system information on the screen. If the loaded information is not correct, press [Rescan] to retrieve the information.

← System Information

Check if the loaded system information is correct, and if it is not, press the "Rescan" button to retrieve the information.

SE Box Serial Number : 000KR0000000 Rescan

Common	ESS1	ESS2	ESS3	ESS4
PMS Serial Number : US2001BSME00000D				
PMS S/W Version : 1.0.1				
App S/W Version : 0.8.0321				
CSIP Library Version : N/A				

Detected ESS : 0

System Name

Press [PCS Settings] > [System Name] to set a system name.

← Please enter the system name.

sysyem1

q	w	e	r	t	y	u	i	o	p
a	s	d	f	g	h	j	k	l	
↑	z	x	c	v	b	n	m	✕	
123	abc		┌				.	↵	

Installation Date

Press [PCS Settings] > [Installation Date] to set the system installation date.

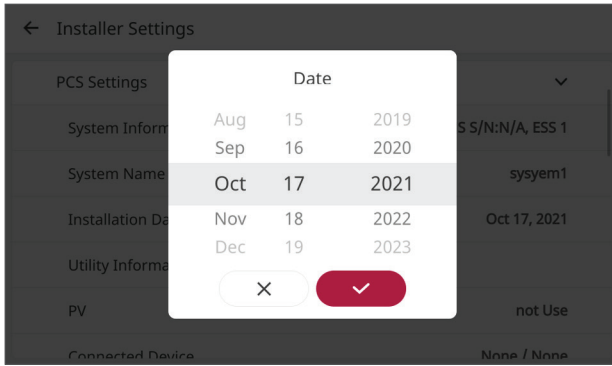

Utility Information

You can set up a communication connection with a utility company and grid profile.

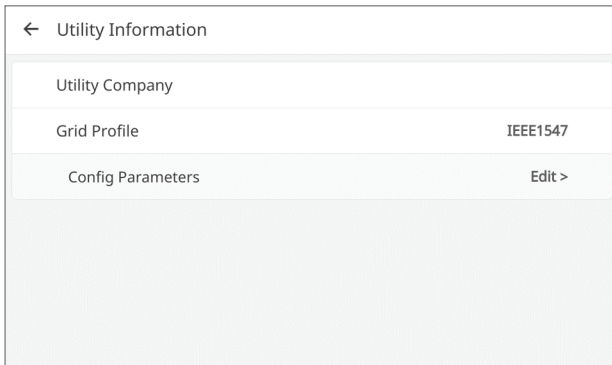

Utility Company

Input the name of a utility company.

Grid Profile

Select the appropriate grid profile option for the system environment.
Select the grid profile at your location.

Config Parameters

Set the config parameters of the selected grid profile. The available config parameters are displayed when you click the "Edit" button.

- Table of field adjustable trip limits for voltage and frequency

Category	Region		Unit	IEEE1547			CA Rule21		
				Default (as shipped)	Min	Max	Default	Min	Max
AC Voltage (% of Nominal Voltage)	OV Level1	Voltage Range	%	110	110	120	110	110	120
		Trip Time Range	sec	13	1	13	13	1	13
	UV Level1	Voltage Range	%	88	0	88	88	50	88
		Trip Time Range	sec	21	21	50	21	21	50
	OV Level2	Voltage Range	%	120	-	-	120	-	-
		Trip Time Range	sec	0.16	-	-	0.16	-	-
	UV Level2	Voltage Range	%	50	0	50	50	-	-
		Trip Time Range	sec	2	2	21	1.5	0.5	21
UV Level3	Voltage Range	%	50	0	50	50	-	-	
	Trip Time Range	sec	2	2	21	1.5	0.5	21	
Frequency	HF Level1	Frequency Range	Hz	61.2	61	66	60.5	60.1	66
		Trip Time Range	sec	300	180	1000	300	0.16	1000
	LF Level1	Frequency Range	Hz	58.5	50	59	58.5	57	59.9
		Trip Time Range	sec	300	180	1000	300	0.16	1000
	HF Level2	Frequency Range	Hz	62	61.8	66	62	62	64
		Trip Time Range	sec	0.16	0.16	1000	0.16	0.16	1000
	LF Level2	Frequency Range	Hz	56.5	50	57	57	53	57
		Trip Time Range	sec	0.16	0.16	1000	0.16	0.16	1000

PV

You can set the connected PV inverter information.

← PV	
PV Inverter	not Use <input type="checkbox"/>
PV Rate Output Power	0kW
Installed PV Panel Capacity	0kWp

If you are using a PV inverter, set the [PV Inverter] option to [Use] and fill the [PV Rate Output Power] and [Installed PV Panel Capacity] fields.

External Device

If you are using an external shutdown switch, set the [External Shutdown Switch] option to [Installed].

You can set any connected devices that are connected to port 1 or port 2. You can set each port to [Modbus] or [AWHP]. If no devices are connected to the ports, it will display as [None].

← External Device	
External Shutdown Switch	Not Installed <input type="checkbox"/>
Port 1	None
Port 2	None

Modbus

If the port setting is set to [Modbus], set the detailed settings such as [Slave ID], [Baud rate], [Start Bit], [Parity], and [Stop Bit].

AWHP

If the port setting is set to [AWHP], set the [AWHP Type] and [Energy Level Setting] options. The AWHP settings run the heatpump with the energy generated by the surplus power of the system.

If the AWHP function is activated, the AWHP status and AWHP energy flow can be checked on the HOME screen.

External Shutdown Switch

To use an external shutdown switch, set the [External Shutdown Switch] option to [Installed].

Operating Mode

You can select a operating mode.

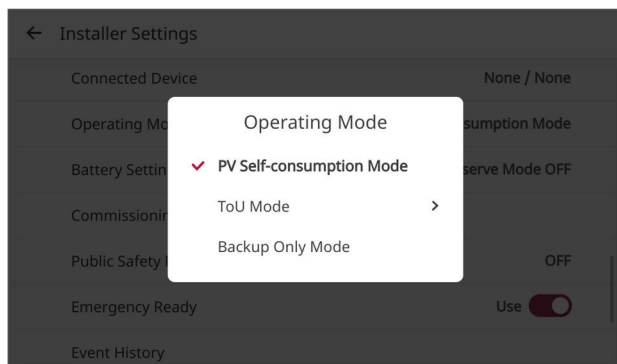

PV Self-consumption Mode

This mode operates by minimizing the power used in the system. Power generated from solar power is supplied to the load and the battery is charged with the remaining surplus power. When the battery is fully charged, the surplus power is supplied to the grid. If the load used power is greater than the solar power, the power stored in the battery is used.

ToU Mode

In this mode, charging/discharging is performed for each section by directly inputting the rate applied for each time period.

Available tables are [Summer/Weekday], [Summer/Weekend], [Winter/Weekday], and [Winter/Weekend]. You can make up to 24 sections with the designated load type. The load type can be set to [Off-Peak], [Shoulder], [Peak], or [Super-Peak].

Backup Only Mode

This mode fully charges the battery in case of a power outage. If this mode is selected, the battery is fully charged and it is not discharged until the mode is changed.

Battery Settings

You can set the battery's reserve SoC level in case of a power outage. The default level is set to 20%.

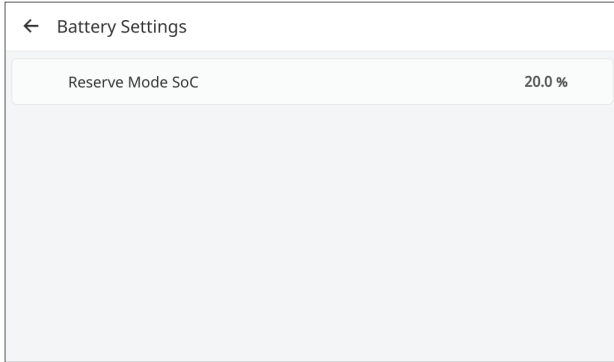

Commissioning Test

All of the relative devices in the [Test Readiness] section should display a ready status before starting the test. If every device is ready to test, press [Start] in the [Charging] and [Discharging] test sections. If the [Test Readiness] section is not at a ready status, [Start] cannot be activated.

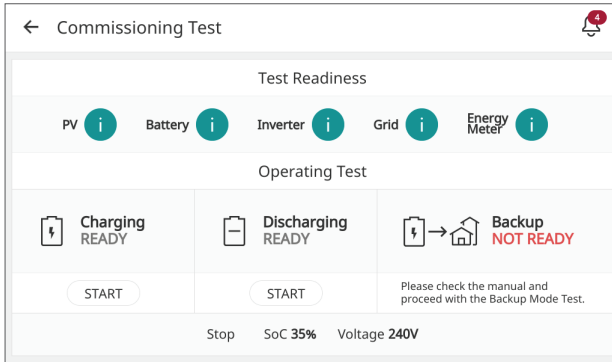

The Charge and Discharge tests are each around 10 minutes. The result is displayed when each test is completed. When there is no problem with the test, [Success] is displayed. When [Fail] is displayed, press each test result to display the detailed information. Check and solve the errors by referring to the error code in the information, then perform the test again. For information on an error code, refer to "Error Codes and Messages".

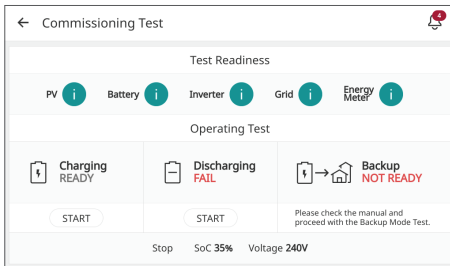
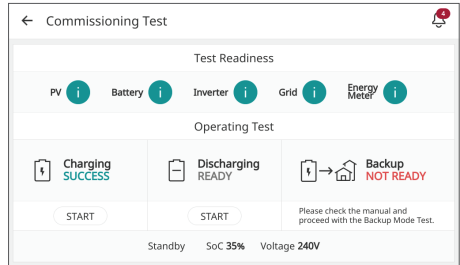
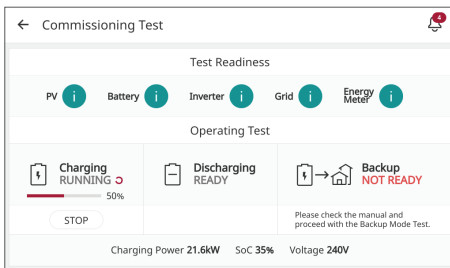

When all charge/discharge tests are successful, the backup test status changes to [READY]. When the [Backup] status is ready, the installer opens the main circuit breaker. If the ESS has successfully obtained backup status, the [Backup] status changes to [RUNNING]. If it fails, the status changes to [FAIL]. If the ESS is in backup status, the installer changes the main circuit breaker to closed. If the grid status is idle for a certain period of time, the grid relay status is closed and the [Backup] state is [SUCCESS].

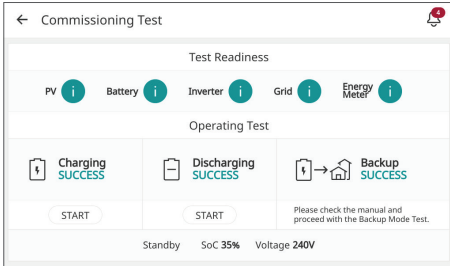
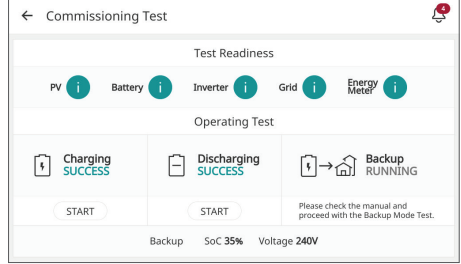
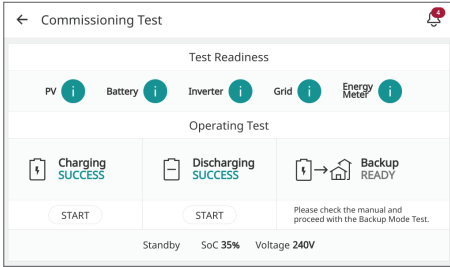

Public Safety Power Shutoffs

If utility companies expect a wildfire or natural disaster, they notify the user of it. After receiving the information, the user can set this function. When you set the start and end time/date, the system fully charges the battery before the set time, considering the current time, the current SoC, and the function start time.

← Public Safety Power Shutoffs	
Limit Transmission	Not Use <input type="checkbox"/>
Start Date	Jan 06, 2019
Start Time	04:00 AM
End Date	Dec 31, 2018
End Time	04:00 AM

Emergency Ready

This function is a method of operating the system to prepare for an insufficient electricity supply due to bad weather that may occur in the near future. Press the [Use/Not Use] switch to enable or disable the function.

← Installer Settings	
Connected Device	None / None
Operating Mode	PV Self-consumption Mode
Battery Settings	Reserve Mode OFF
Commissioning Test	
Public Safety Power Shutoffs	OFF
Emergency Ready	Use <input checked="" type="checkbox"/>
Event History	

INFO

To use the [Emergency Ready] function, the system must be registered through the LG ThinQ® application.

Event History

If an error occurs in the system, the current error information is displayed.

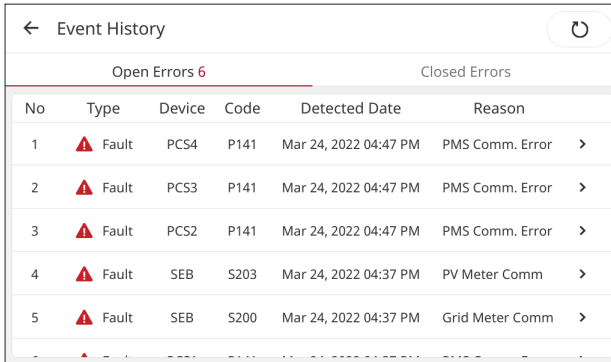

Open Errors 6						Closed Errors
No	Type	Device	Code	Detected Date	Reason	
1	Fault	PCS4	P141	Mar 24, 2022 04:47 PM	PMS Comm. Error	>
2	Fault	PCS3	P141	Mar 24, 2022 04:47 PM	PMS Comm. Error	>
3	Fault	PCS2	P141	Mar 24, 2022 04:47 PM	PMS Comm. Error	>
4	Fault	SEB	S203	Mar 24, 2022 04:37 PM	PV Meter Comm	>
5	Fault	SEB	S200	Mar 24, 2022 04:37 PM	Grid Meter Comm	>

[Level] shows the severity of the error, [Device] shows the information of the device where the error occurred, and [Code] shows the error code.

Backup

You can enable or disable backup mode. If you are using backup mode, you can set the detailed settings for backup mode.

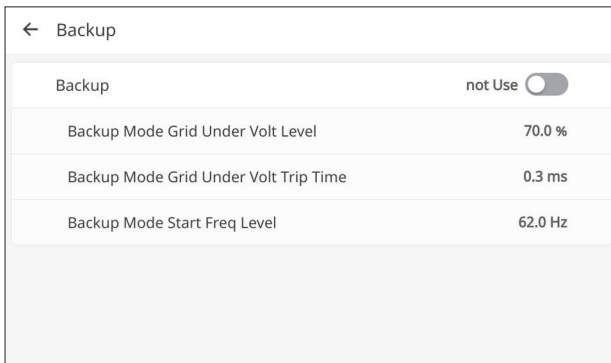

Backup	
Backup	not Use <input type="checkbox"/>
Backup Mode Grid Under Volt Level	70.0 %
Backup Mode Grid Under Volt Trip Time	0.3 ms
Backup Mode Start Freq Level	62.0 Hz

Backup Mode Grid Under Volt Level

It sets the lower limit level of Grid Voltage to determine when backup mode will operate.

Backup Mode Grid Under Volt Trip Time

It sets the minimum time for the Grid Trip to determine when backup mode will operate.

Backup Mode Start Freq Level

It sets the start frequency level to determine when backup mode will operate.

EnerVu Settings (Installer Only)

To use the EnerVu web monitoring system, the ESS system must be registered through the LG ThinQ® application first. Then, the installer can add the system in EnerVu. After registering in EnerVu, the installer can check a variety of information such as system status, information, report, etc.

Preparation

- An internet browser installed on a computer, tablet, or mobile phone with internet access is needed to access the EnerVu web monitoring system.
- This product must be connected to the internet. Check the [Network Type] settings menu in the system.

Creating a New Account (Administrator)

An administrator can manage the installers belonging to the company and its branches. An administrator also has all the roles that installers have.

1

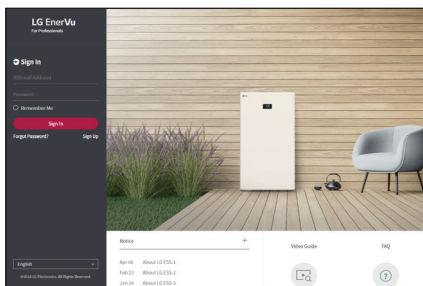

In a browser, visit the LG EnerVu website at <https://na.enervu.lg-ess.com>.

The [Sign In] page will appear.

2

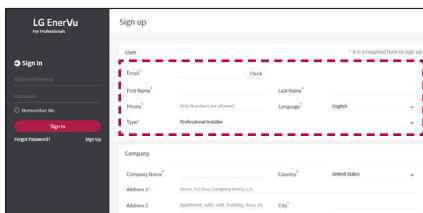

Select [Sign Up]. The [Sign Up] page appears.

Input your email address in the [Email] field and select [Check].

Then, fill out all of the other fields.

3

Fill the required information in the [Company] section.

Read the [Installer Terms Of Use], [Installer Privacy Policy] and [Installer Age Policy] carefully. If you agree with all of the terms and policies, click the [I agree] check box in each section.

4

Select [Submit] to complete creating an installer account.

Adding a New Installer

1

In your browser, visit the LG EnerVu website at <https://na.enervu.lg-ess.com>.

The [Sign In] page will appear. Input the administrator's E-mail address and password, then select [Sign In].

2

Name	Company	Active
LEE LEE	Edison and Subcontractor	Y
Tony Hest	Edison and Subcontractor	Y

Select [Professionals] under the [Account] menu.

Select the [Add New User] button to open a new user input pop-up.

3

New User [X]

Email*

An email describing the subscription procedure will be sent.

First Name* Last Name*

Language Role

Company Name

Enter the email address for the new installer account and select [Check].

Enter the first name and last name of the new installer.

Select the proper language and [Role].

In [Role], you can select either [Professionals] or [Administrator].

Professional is used for an installer that has no authority to add users or subsidiaries.

Select the [Company Name] option to designate as either a parent company or subsidiary.

Then, select the [OK] button to register the new installer.

4

LG EnerVu

LG's powerful Solar & ESS Solutions
are used on many residential roofs, Solar and ESS projects

Congratulations!

A new EnerVu account has been created.
Click the link below to create a password.

<https://b-enervu.lg-ess.com/v2/account/reset-form.do?securityKey=341U30FBFCXR6T8RUB0EJN8AQFCW8U4NU69J2FEDTH064018@yopmail.com&type=new>

If nothing happens when you click the link, copy the link to the address bar of your web browser.
The link expires in 7 Days due to security reasons.

The new installer will receive an email from EnerVu.

The new installer should reset their password by clicking the link in the email.

Then, the new installer can sign to EnerVu.

Registering The System (Web Browser)

The installer should follow the procedures below in EnerVu so that Installer can monitor the customer's system through the EnerVu.

1

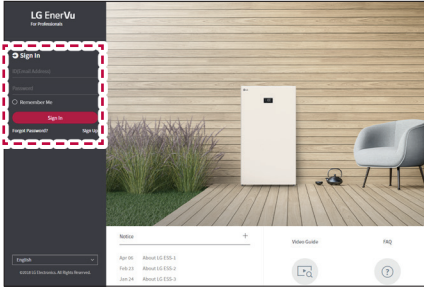

In a browser, visit the LG EnerVu website at <https://na.enervu.lg-ess.com>.

The [Sign In] page will appear. Enter the installer's email address and password, then select [Sign In].

If the installer does not have an account, select [Sign Up] to create a new installer account.

2

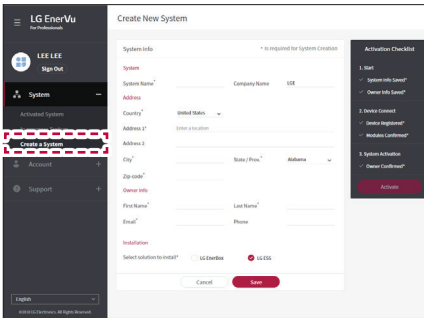

Select [Create a System] under the [System] menu.

Fill in all of the information in the [System Info] section and select [Save] to save the entries.

3

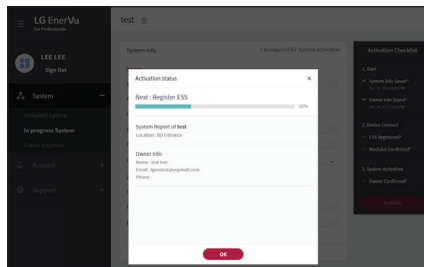

Select [OK] to go to next step.

4

In the [ESS Info] field, enter the product SE Box serial number and select [Check].

If SE Box serial number is valid, the other ESS information fields will automatically be filled.

Select [Save] to go to the next step.

5

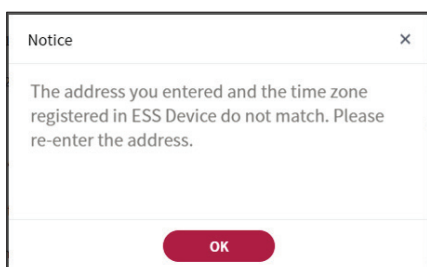

If the previous steps have been successfully done, the installer can now monitor the ESS system.



INFO

If the time zone settings on the system do not match the monitoring system, check the region of the installed ESS system and edit the time zone settings of the system again.

Incomplete Registration Status

If the registration is incomplete, the system should be activated through the following steps.

1

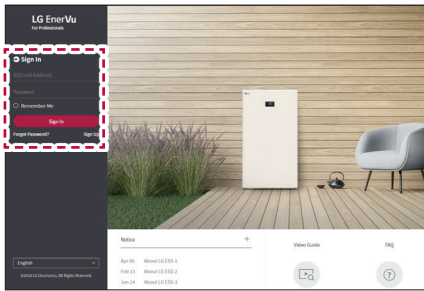

In a browser, visit the LG EnerVu website at <https://na.enervu.lg-ess.com>.

The [Sign In] page will appear. Enter the installer's email address and password, then select [Sign In].

2

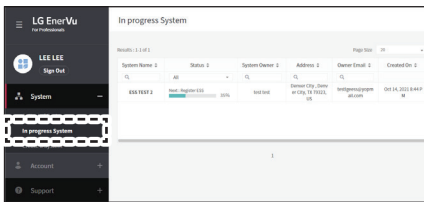

Select [In progress System] under the [System] menu.

Choose the name of the system you would like to monitor.

3

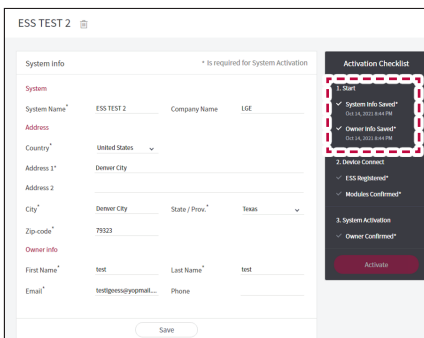

Many times, the system has an incomplete status because the time zone setting in the ESS system does not match the EnerVu system settings.

If this is the case, the ESS system will not be registered. Please return to Step 1.

Next, check the region that the system is in and set the time zone again.

If the above condition is fulfilled, the installer can then add and monitor the ESS system.

Using LG ThinQ® Applications (For User)

INFO

To use the LG ThinQ® Application, the SE Box must be connected to the Internet.

Installing LG ThinQ®

Search for the LG ThinQ® application in the Google® Play Store or Apple® App Store® on a mobile phone.

Apple® and App Store® are registered trademarks of Apple, Inc.

Google® is a trademark of Google LLC.

Follow the instructions to download and install the application.

INFO

If you choose the simple login method to access the LG ThinQ® application, you must go through the system registration process each time you change your mobile phone or reinstall the application.

Registering the System

The SE Box should already be connected to a router or the Internet directly (For example, using an LTE modem)

1. Run the LG ThinQ® application on a mobile phone.
2. Create an account and sign in.
3. Select [Add a Device] > [Select Device].
4. Select [ESS Home].

Using LG ThinQ®

On your SE Box

1. On your SE Box display, press  > [Settings] > [General Settings].
2. Set the [Soft AP] option to [Active] state.

On a Mobile Phone

1. Select the system in the application and connect it to a Wireless network.
2. Select the menu on the upper right side to access the settings and features.

Firmware Update

Keeps the system performance updated.

Settings

Allows you to set various options in the system and the application.



INFO

- If you change your wireless router, your Internet service provider, or your password after registering the appliance, please delete the network in LG ThinQ® Settings > Edit Product and register it again.
- The application is subject to change for appliance improvement purposes without notice.
- Functions may vary by model.

 **INFO**

- To verify the Wi-Fi connection, check that the Wireless icon on the control panel is lit.
- The appliance supports 2.4GHz wireless networks only. To check your network frequency, contact your Internet service provider or refer to your wireless router manual.
- LG ThinQ® is not responsible for any network connection problems or any faults, malfunctions, or errors caused by network connection.
- If the system is having trouble connecting to the wireless network, it may be too far from the router.
- Purchase a wireless repeater (range extender) to improve the wireless signal strength.
- The wireless connection may not connect or may be interrupted due to the home network environment.
- The network connection may not work properly depending on the Internet service provider.
- The surrounding wireless environment can cause the wireless network service to run slowly.
- The appliance may not be able to be registered due to problems with the wireless signal transmission.
- Unplug the appliance and wait about a minute before trying again.
- If the firewall on your wireless router is enabled, disable the firewall or add an exception.
- The wireless network name (SSID) should be a combination of English letters and numbers. (Do not use special characters.)
- The smartphone user interface (UI) may vary depending on the mobile operating system (OS) and the manufacturer.
- If the security protocol of the router is set to WEP, you may fail to set up the network. Please change it to another security protocol (WPA2 is recommended) and register the product again.
- If the system is not available to connect to a wireless network, request an installer to connect the system through a wired connection and use the LG ThinQ® app with mobile data or cellular data.

Error Codes and Messages

PCS Error Codes

- Do not leave the ESS in a faulty state for a long time, as the remaining battery capacity may be decreased during that period.
- If the BMS generates fault information and disconnects the power after starting PCS, it means that the battery has a problem. Check the battery SoC, voltage, and fault information and turn off the power of the ESS until service is performed.
- If the battery SoC is low, the battery may be charged from the grid by using the self protection function (Emergency charging). This function is to prevent the shutdown of the ESS, battery deep discharge, and battery damage. Emergency charging is not an ESS fault, but a normal procedure.

Code	Description	Solution
P105	BAT 1 Disconnect	Contact service center
P110	BAT 1 MisWiring	Contact service center
P120	Grid MisWiring	Contact service center
P130	BAT Relay Error	Contact service center
P131	Grid Relay Error	Contact service center
P140	Slave MCU Comm.	Contact service center
P141	PMS Comm. Error	Contact service center
P142	BAT Comm. Error	Contact service center
P150	Backup SoftStart	Contact service center
P151	Backup Fail	Reboot the system
P152	Backup Low SOC	Automatically restart after releasing fault
P203	Grid OV	Automatically restart after grid voltage is normal
P213	Grid UV	Automatically restart after grid voltage is normal
P220	Grid OF	Automatically restart after grid frequency is normal
P221	Grid UF	Automatically restart after grid frequency is normal
P230	L1 DC OffsetCurr	Automatically restart after releasing fault
P240	Anti-Islanding	Automatically restart after releasing fault
P300	BAT 1 OV	Automatically restart after battery voltage is normal
P310	BAT 1 UV	Automatically restart after battery voltage is normal
P320	BAT 1 OC	Automatically restart after battery current is normal
P330	BAT 1 OC HW	Automatically restart after battery current is normal
P350	BAT 1 Low SOC	Automatically restart after battery SOC is normal
P351	BAT1 State Error	Automatically restart after battery state is normal

Code	Description	Solution
P353	BAT 1 Sleep	Automatically restart after battery black start operation is normal
P354	BAT 1 Power Down	Automatically restart after battery black start operation is normal
P370	DC Link OV	Automatically restart after DC-Link voltage is normal
P371	DC Link OV HW	Automatically restart after DC-Link voltage is normal
P372	DC Link UV	Automatically restart after DC-Link voltage is normal
P500	Grid L1 OC	Automatically restart after grid current is normal
P503	Grid N OC	Automatically restart after grid current is normal
P510	Grid L1 OC HW	Automatically restart after grid current is normal
P513	Grid N OC HW	Automatically restart after grid current is normal
P550	Backup L1 OV	Automatically restart after releasing fault
P551	Backup L2 OV	Automatically restart after releasing fault
P560	Backup Total OL	Automatically restart after releasing fault
P561	Backup L1 OL	Automatically restart after releasing fault
P562	Backup L2 OL	Automatically restart after releasing fault
P580	Backup Volt Fail	Automatically restart after releasing fault
P600	Grid Relay1	Automatically restart after releasing fault
P601	Grid Relay2	Automatically restart after releasing fault
P602	Grid Relay3	Automatically restart after releasing fault
P603	Grid Relay4	Automatically restart after releasing fault
P604	Grid Relay5	Automatically restart after releasing fault
P605	Grid Relay6	Automatically restart after releasing fault
P606	Grid Relay7	Automatically restart after releasing fault
P607	Grid Relay8	Automatically restart after releasing fault
P612	BAT Relay1	Automatically restart after releasing fault
P613	BAT Relay2	Automatically restart after releasing fault
P631	Inverter SW1 OT	Automatically restart after INV L1 top temp is normal
P632	Inverter SW2 OT	Automatically restart after INV L1 bottom temp is normal
P633	Inverter SW3 OT	Automatically restart after INV L2 top temp is normal
P634	Inverter SW4 OT	Automatically restart after INV L2 bottom temp is normal
P635	Inverter SW5 OT	Automatically restart after INV N top temp is normal
P636	Inverter SW6 OT	Automatically restart after INV N bottom temp is normal

Code	Description	Solution
P651	BAT Conv. SW1 OT	Automatically restart after Converter top temp is normal
P652	BAT Conv. SW2 OT	Automatically restart after Converter bottom temp is normal
P690	PCS Internal OT	Automatically restart after Inner temp is normal
P700	Slave MCU Comm.	Automatically restart after Communication is normal
P701	PMS Comm. Error	Automatically restart after Communication is normal
P702	BAT1 Comm. Error	Automatically restart after Communication is normal
P720	Slave MCU Error	Automatically restart after releasing fault
P721	MCU Power Fault	Automatically restart after MCU Control Power is normal
P722	GD Desat	Automatically restart after releasing fault
P723	GD Low Voltage	Automatically restart after releasing fault
P724	Temp. Sensor	Automatically restart after temp. sensor is normal
P740	ATS Error	Automatically restart after ATS is normal
P741	Initial Charge	Automatically restart after releasing fault
P750	Grid Volt Sensor	Automatically restart after grid voltage sensing is normal
P751	Grid Freq Sensor	Automatically restart after grid frequency sensing is normal
P752	Safety Function	Automatically restart after safety function operation is normal
P753	Micom State Fail	Automatically restart after MICOM state is normal
P760	SRD Para Fault	Automatically restart after releasing fault
P765	Relay Power Off	Automatically restart after relay is normal
P900	SRD Para Warning	Automatically restart after releasing fault
P910	Eeprom Warning	Automatically restart after releasing fault
P925	PMS E-Stop	Automatically restart after releasing stop

SE Box Error Code

Code	Description	Solution
S100	PCS version does not match	Contact service center
S101	BMS version does not match	Contact service center
S102	EEPROM device error	Contact service center
S200	Grid meter communication error	Contact service center

Code	Description	Solution
S201	Grid L1 is miswired	Contact service center
S202	Grid L2 is miswired	Contact service center
S203	PV meter communication error	Contact service center
S204	PV meter is miswired	Contact service center
S205	PV meter is miswired	Contact service center

Battery Error Code

Code	Description	Solution
B050	Discharge current level is higher than the limit	Automatically released after warning condition is cleared
B051	Charge current level is higher than the limit	Automatically released after warning condition is cleared
B053	Discharge Atmosphere temperature level is higher than the limit	Automatically released after warning condition is cleared
B054	Discharge Atmosphere temperature level is lower than the limit	Automatically released after warning condition is cleared
B055	Charge Atmosphere temperature level is higher than the limit	Automatically released after warning condition is cleared
B056	Charge Atmosphere temperature level is lower than the limit	Automatically released after warning condition is cleared
B100	Discharge temperature level is higher than the limit	Automatically released after warning condition is cleared
B101	Discharge temperature level is lower than the limit	Automatically released after warning condition is cleared
B102	Charge temperature level is higher than the limit	Automatically released after warning condition is cleared
B103	Charge temperature level is lower than the limit	Automatically released after warning condition is cleared
B104	Power Terminal temperature level is higher than the limit	Automatically released after warning condition is cleared
B150	Discharge Power level is higher than the limit	Automatically released after warning condition is cleared
B151	Charge Power level is higher than the limit	Automatically released after warning condition is cleared
B153	MCU AD interrupt operation warning	Automatically released after warning condition is cleared
B155	Fan is not working	Automatically released after ESS system restart

Code	Description	Solution
B157	CRC data safety memory range warning	Contact service center
B300	Cell Voltage level of battery cell is higher than the limit	Automatically restart after fault condition is cleared
B301	Cell Voltage level of battery cell is lower than the limit	Contact service center
B305	Unit voltage AD conversion multiplex fault	Automatically restart after fault condition is cleared
B350	Discharge current level is higher than the limit	Automatically restart after fault condition is cleared
B351	Charge current level is higher than the limit	Automatically restart after fault condition is cleared
B353	Discharge Atmosphere temperature level is higher than the limit	Automatically restart after fault condition is cleared
B354	Discharge Atmosphere temperature level is lower than the limit	Automatically restart after fault condition is cleared
B355	Charge Atmosphere temperature level is higher than the limit	Automatically restart after fault condition is cleared
B356	Charge Atmosphere temperature level is lower than the limit	Automatically restart after fault condition is cleared
B357	Current AD conversion multiplex fault	Automatically restart after fault condition is cleared
B400	Discharge temperature level is higher than the limit	Automatically restart after fault condition is cleared
B401	Discharge temperature level is lower than the limit	Automatically restart after fault condition is cleared
B402	Charge temperature level is higher than the limit	Automatically restart after fault condition is cleared
B403	Charge temperature level is lower than the limit	Automatically restart after fault condition is cleared
B404	Power Terminal temperature level is higher than the limit	Automatically restart after fault condition is cleared
B458	MCU OSC HR error	Automatically restart after releasing fault
B459	Internal Communication Error (BCU ↔ BIC)	Automatically restart after releasing fault
B460	External Communication Error (BCU ↔ PCS)	Automatically restart after releasing fault
B461	Watchdog counter error	Automatically restart after releasing fault
B463	MCU CORE register error	Automatically restart after releasing fault
B464	MCU FPU register error	Automatically restart after releasing fault
B465	MCU VCU register error	Automatically restart after releasing fault

Code	Description	Solution
B466	MCU PIE RAM error	Automatically restart after releasing fault
B467	MUC PIE handler error	Automatically restart after releasing fault
B468	MCU ROM ECC error	Automatically restart after releasing fault
B469	MCU RAM ECC error	Automatically restart after releasing fault
B470	MCU clock error	Automatically restart after releasing fault
B471	MCU RAM 1 error	Automatically restart after releasing fault
B472	MCU RAM 2 error	Automatically restart after releasing fault
B473	MCU oscillator source error	Automatically restart after releasing fault
B600	Cell Voltage level of battery cell is higher than the limit	Contact service center
B601	Cell Voltage level of battery cell is lower than the limit	Contact service center
B603	Unit Voltage level of battery cell is higher than the limit	Contact service center
B604	Unit Voltage level of battery cell is lower than the limit	Contact service center
B606	Cell voltage difference between battery cells is higher than the limit	Contact service center
B607	Pack voltage difference between battery packs is higher than the limit	Contact service center
B650	Discharge current level is higher than the limit	Contact service center
B651	Charge current level is higher than the limit	Contact service center
B653	Discharge Atmosphere temperature level is higher than the limit	Contact service center
B654	Discharge Atmosphere temperature level is lower than the limit	Contact service center
B655	Charge Atmosphere temperature level is higher than the limit	Contact service center
B656	Charge Atmosphere temperature level is lower than the limit	Contact service center
B700	Discharge temperature level is higher than the limit	Contact service center
B701	Discharge temperature level is lower than the limit	Contact service center
B702	Charge temperature level is higher than the limit	Contact service center
B703	Charge temperature level is lower than the limit	Contact service center

Code	Description	Solution
B704	Power Terminal temperature level is higher than the limit	Contact service center
B754	Battery power supply relay operation fault	Contact service center
B756	Reset count error	Contact service center
B758	BIC AD reference voltage error	Contact service center
B759	Cell sensor wire connection error	Contact service center
B760	Temperature sensor error	Contact service center
B761	Current sensor error	Contact service center
B764	Unit high voltage sensor error	Contact service center
B765	Circuit breaker switch is open	Contact service center
B766	Fault checking operation error	Contact service center
B767	Battery pack count error	Contact service center
B768	MCU AD conversion error	Contact service center
B769	Cell temperature AD conversion error	Contact service center
B770	Cell voltage AD conversion	Contact service center
B771	MCU AD reference voltage error	Contact service center

- Firmware version, Error codes, and Fault conditions can be accessed on the display. They can also be accessed from the server.

Contact

If you have any technical problems or questions, contact the installation company or LGEUS.

1. Installation Company Address :
2. LG Electronics ESS Service
 ATTN: Electro-Tech Services, Inc. 19481 SAN JOSE AVE. CITY OF INDUSTRY CA 91748
 (833) 940-5010
esssvc.lge@etssi.com

Black Start

Black Start is a wake-up function for when the Home 8 is in sleep mode.

The Home 8 will go into sleep mode to protect the battery from over-discharging when the SoC of the Home 8 has reached 0%. (e.g. In case the surplus energy from the PV system is not enough to charge the battery during a power outage.)

The user or installer should press and hold the BLACK START (6s) button for more than 6 seconds when the battery can be recharged by the PV system or the utility grid. If 2 or more Home 8 units are installed, press the BLACK START (6s) button on each Home 8 unit.

This feature could be still used in a power outage. In general, during a power outage, the PV system will not operate if the Home 8 is in sleep mode due to reaching 0% SoC with no backup power. In this case, however, the user or installer can wake up the Home 8 in the morning, and then the Home 8 will be charged from the PV system WITHOUT supplying the backup load. Once the SoC of the Home 8 has reached the specific SoC level and has met other conditions, the system will automatically supply the backup power to the backup load with the PV system.

The user or installer should wake up the Home 8 even though the utility grid has been recovered after the Home 8 is in sleep mode. In this case, the Home 8 will be charged from the utility grid up to the specific SoC level and the system will automatically operate following the pre-set operating mode.



INFO

- SoC 0 % means the battery has run out of capacity. When the SoC reaches 0 %, an alarm is sent through EnerVu and the LED Indications display 0 %.
- When running the Black Start function, the battery will first start charging, and after a certain amount of charging, the system will operate normally using battery power.
- Before pressing the Black Start Button, make sure that the PV is operating normally.

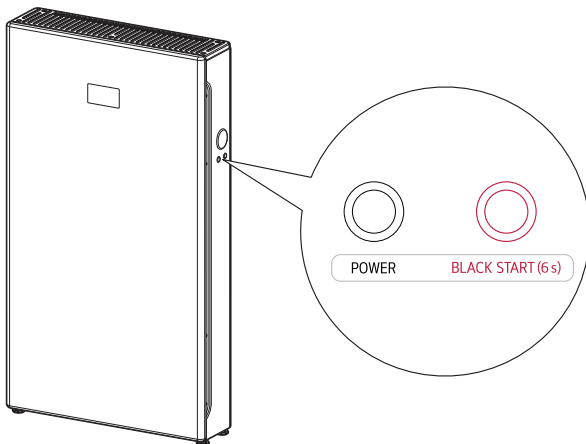

Maintenance



WARNING

Be sure to turn off the product and inspect it.

Cleaning the Product

Wipe off the outside of the product with a soft towel moistened with lukewarm water and a neutral detergent, then wipe it with a clean hand towel so that dirt will not be attracted to the product.

When cleaning the outside of the product, do not use a rough brush, toothpaste, or flammable materials. Do not use cleaning agents containing flammable substances.

- It may cause discoloration or damage the product.
- Flammable substances: Alcohol (Ethanol, Methanol, Isopropyl alcohol, Isobutyl alcohol, etc.), Thinners (Benzene, Flammable liquid, Abrasives, etc.)

Cleaning with strong pressure while cleaning may damage the surface. Do not leave rubber or plastic products in contact with the product for a long period of time.

Inspecting Regularly

It is recommended to check the operating status and connection status at least once a year. It should be done by a trained service provider. Contact an authorized dealer or the seller you purchased the system from.

- The capacity may decrease as the battery ages.
- The value for the battery cell only (depth of discharge 95%) capacity may be limited to protect the system.

Shutting Down the System

The ESS should be turned off when not in use for a long period of time or when maintenance is required.

1. Open the front cover of the SE Box. Set the  > [Settings] > [PCS Settings] > [Operation] option on the SE Box display to [Stop].

If the optional STOP SWITCH is connected to the SE Box, operate the STOP switch and check that the  > [Settings] > [PCS Settings] > [Operation] option on the SE Box display is set to [Stop].

2. Press the POWER button on the Home 8 and open the front door of the Home 8.
3. Switch the battery circuit breaker on the Home 8 to the OFF position and close the front case of the Home 8.
4. Switch every circuit breakers on the SE Box side to the OFF position and close the front case of the SE Box.

Disposing the product

When the product reached to the end of its service life or defect beyond repair, dispose the product according to the disposal regulations for electronic waste in your area. Disposing the product must be carried out by qualified personnel only. Contact authorized dealer or where you purchased.



1. This crossed-out wheeled bin symbol indicates that waste electrical and electronic products (WEEE) should be disposed of separately from the municipal waste stream.
2. Old electrical products can contain hazardous substances so correct disposal of your old appliance will help prevent potential negative consequences for the environment and human health.
Your old appliance may contain reusable parts that could be used to repair other products, and other valuable materials that can be recycled to conserve limited resources.
3. You can take your appliance either to the shop where you purchased the product, or contact your local government waste office for details of your nearest authorised WEEE collection point. For the most up to date information for your country please see www.lg.com/global/recycling

Removal of waste batteries and accumulators (Product with embedded battery ONLY)

You can take your appliance either to the shop where you purchased the product, or contact your local government waste office for details of your nearest authorised WEEE collection point. Please note that some distributors are obliged:

- to take back old devices from end-users upon selling a new equivalent equipment to them and
- provide free-of-charge collection for electrical and electronic equipment of very small dimensions (not exceeding 25 cm) without the obligation for end-users to purchase new equipment of an equivalent type.

When distributors deliver new equipment to private households, they are obligated to collect old equipment directly from them or to propose a take-back solution in a reasonable distance. Therefore, we recommend you to contact your distributor for more information.

LG Electronic Deutschland GmbH is duly registered as Producer in Germany. As such, LG contributes to the country-wide collection and recycling of WEEE that you bring to municipal separate collection facility. For the most up to date information please see www.lg.com/global/recycling.

Compliance Information

[USA]

FCC Notice

The following notice covers the transmitter module contained in this product.

This equipment has been tested and found to comply with the limits for a Class B digital device, pursuant to Part 15 of the FCC Rules. These limits are designed to provide reasonable protection against harmful interference in a residential installation. This equipment generates, uses, and can radiate radio frequency energy and, if not installed and used in accordance with the instructions, may cause harmful interference to radio communications. However, there is no guarantee that interference will not occur in a particular installation. If this equipment does cause harmful interference to radio or television reception, which can be determined by turning the equipment off and on, the user is encouraged to try to correct the interference by one or more of the following measures:

- Reorient or relocate the receiving antenna.
- Increase the separation between the equipment and the receiver.
- Connect the equipment to an outlet on a circuit different from that to which the receiver is connected.
- Consult the dealer or an experienced radio/TV technician for help.

This device complies with Part 15 of the FCC Rules. Operation is subject to the following two conditions:

- 1) this device may not cause harmful interference; and
- 2) this device must accept any interference received, including interference that may cause undesired operation of the device.

Any changes or modifications in construction of this device which are not expressly approved by the party responsible for compliance could void the user's authority to operate the equipment.

FCC RF Radiation Exposure Statement

This equipment complies with FCC radiation exposure limits set forth for an uncontrolled environment. This equipment should be installed and operated with minimum distance 20 cm between the radiator and your body. End users must follow the specific operating instructions for satisfying RF exposure compliance. This transmitter must not be co-located or operating in conjunction with any other antenna or transmitter.

Supplier's Declaration of Conformity	
Trade Name	LG
Responsible Party	LG Electronics USA, Inc.
Address	111 Sylvan Avenue, North Building Englewood Cliffs, New Jersey 07632
E-mail	lg.environmental@lge.com

[CANADA]

Industry Canada Statement (For transmitter module contained in this product)

CAN ICES-3 (B)/NMB-3(B)

This device complies with Industry Canada's applicable licence-exempt RSSs. Operation is subject to the following two conditions:

- (1) This device may not cause interference; and
- (2) This device must accept any interference, including interference that may cause undesired operation of the device.

IC Radiation Exposure Statement

This equipment complies with IC radiation exposure limits set forth for an uncontrolled environment. This equipment should be installed and operated with a minimum distance of 20 cm (7.8 inches) between the antenna and your body.

NOTE: THE MANUFACTURER IS NOT RESPONSIBLE FOR ANY RADIO OR TV INTERFERENCE CAUSED BY UNAUTHORIZED MODIFICATIONS TO THIS EQUIPMENT. SUCH MODIFICATIONS COULD VOID THE USER'S AUTHORITY TO OPERATE THE EQUIPMENT.

Avis d'Industrie Canada [Pour la fonction sans fil (WLAN, Bluetooth, etc.)]

CAN ICES-003(B) / NMB-003(B)

L'émetteur/récepteur exempt de licence contenu dans le présent appareil est conforme aux CNR d'Innovation, Sciences et Développement économique Canada applicables aux appareils radio exempts de licence. L'exploitation est autorisée aux deux conditions suivantes :

- 1) L'appareil ne doit pas produire de brouillage;
- 2) L'appareil doit accepter tout brouillage radioélectrique subi, même si le brouillage est susceptible d'en compromettre le fonctionnement.

Avis d'Industrie Canada sur l'exposition aux rayonnements [Pour la fonction sans fil (WLAN, Bluetooth, etc.)]

Cet appareil est conforme aux limites d'exposition aux rayonnements d'Industrie Canada pour un environnement non contrôlé. Cet appareil doit être installé de façon à garder une distance minimale de 20 cm (7,8 po) entre la source de rayonnement et votre corps.

REMARQUE : LE FABRICANT N'EST PAS RESPONSABLE DES INTERFÉRENCES RADIOÉLECTRIQUES CAUSÉES PAR DES MODIFICATIONS NON AUTORISÉES APPORTÉES À CET APPAREIL. DE TELLES MODIFICATIONS POURRAIENT ANNULER L'AUTORISATION ACCORDÉE À L'UTILISATEUR DE FAIRE FONCTIONNER L'APPAREIL.

Specifications

Home 8 - General Specifications

Nominal Voltage (L-N/L-L)	120/240V Split Phase
Grid Frequency (Nominal)	60 Hz
Rated AC Power (Discharging)	7.5 kVA ¹⁾
Rated AC Power (Charging)	5.4 kVA ¹⁾
Total Capacity	15.8 kWh
Usable Capacity	14.4 kWh ²⁾
Round Trip Efficiency	> 90 % ^{3) 4)}
CEC Efficiency (PCS only)	98%
Overvoltage Category	Category IV
Interface	LED Display

Home 8 - Grid connection mode

Nominal Voltage (L-N/L-L)	120/240V Split Phase
Grid Frequency (Nominal)	60 Hz
Rated AC Power (Discharging)	7.5 kVA ¹⁾
Rated AC Power (Charging)	5.4 kVA ¹⁾
Rated AC Current (Discharging)	31.25 A
Rated AC Current (Charging)	22.5 A
Power Factor	- 0.8 — +0.8

- 1) Adjustable, limited by the battery pack output capability such as charging/discharging power derating by the atmosphere temperature.
- 2) Usable energy may be limited for enhancing the battery lifespan and system stability. The capacity may decrease as the battery ages.
- 3) Verified according to LG Electronics conditions.
- 4) AC to battery to AC with 4.32 kW charging and 2.88kW discharging power at 25°C (77°F) at the beginning of life.

Home 8 - Backup mode

Nominal AC Voltage	120/240V Split Phase
Nominal AC Frequency	60 Hz
Max AC Power (Discharging)	9.0 kVA (10s)
Rated AC Power (Discharging)	7.5 kVA ¹⁾
Rated AC Power (Charging)	5.4 kVA ¹⁾
Max AC Current (Discharging)	37.5 A (10s)
Rated AC Current (Discharging)	31.25 A
Rated AC Current (Charging)	22.5 A

Home 8 - Battery

Battery Package Types	Cylindrical Li-ion
Total Capacity	15.8 kWh
Usable Capacity	14.4 kWh ²⁾
Nominal DC Voltage	406.56 V

Home 8 - Battery Module (Service Part)

Battery Package Types	Cylindrical Li-ion
Module Nominal DC Voltage	101.64 V
Module Capacity (min. / Nominal)	36.9 Ah / 38.9 Ah
Module Size [W*H*D]	600 x 212 X 190 [mm] (23.6 x 8.4 x 7.5 [in])
Module Weight (Max)	26 kg / 57 lb

- 1) Adjustable, limited by the battery pack output capability such as charging/discharging power derating by the atmosphere temperature.
- 2) Usable (typical) energy may be limited for enhancing the battery lifecycle and system stability. The capacity may decrease as the battery ages.

SE Box - General Specifications

Nominal Voltage (L-N/L-L)	120/240V Split Phase
Grid Frequency (Nominal)	60 Hz
Max AC Current Rating	200 A
Max Continuous AC Current Rating	160 A
Input Short Circuit Current Rating	10 kAIC ⁵⁾
Over Current Protection Device	100 ~ 200 A, Service Entrance Rated ^{5) 6)}
AC Meter Accuracy	+/- 2 %
Operating Mode	PV Self-Consumption, Time of Use (ToU), Backup Only
Backup Operation	Automatic Disconnect for Seamless Backup
Backup Transfer Time	< 100 ms
Modularity	Up to 4 Home 8 units
Overvoltage Category	Category IV

SE Box - Interfaces

User Interface	7-inch Touch LCD, LG ThinQ App (User), EnerVu Web (Installer)
Internet Connection	Ethernet 10/100, WLAN (802.11 b/g/n)
External Device	MODBUS

- 5) When protected by Class J fuses, LG SE Box is suitable for use in circuits capable of delivering no more than 22kA symmetrical amperes.
- 6) LG SE Box is not suitable for use as service equipment in Canada.

Environmental Specification

	Home 8	SE Box
Dimensions[W*H*D]	698 X 1260 X 205 [mm] (27.5 X 49.6 X 8.1 [in])	500 X 600 X 178 [mm] (19.7 X 23.6 X 7.0 [in])
Weight	163 kg / 359 lb	25 kg / 55 lb
Cooling	Fan (Forced Air Cooling)	Natural Convection
Operating Temperature	Discharging: -20 ~ 50 °C (-4 ~ 122 °F)	-20 ~ 50 °C (-4 ~ 122 °F)
	Charging: -10 ~ 45 °C (14 ~ 113 °F)	
Recommended Operating Temperature	Discharging: 0 ~ 35 °C (32 ~ 95 °F)	-20 ~ 50 °C (-4 ~ 122 °F)
	Charging: 0 ~ 33 °C (32 ~ 91.4 °F)	
Storage Temperature	-20 ~ 50 °C (-4 ~ 122 °F)	
Ambient Humidity (RH)	5 ~ 95 %	
Protection Rating	NEMA Type 3R ⁷⁾	
Altitude	< 3000 m (9843 ft)	
Seismic Category	IEEE 693	
Mounting Type	Floor Stand with Wall support	Wall Mount
Noise	< 47 dB	
Limited Warranty	See URL for full Limited Warranty ⁸⁾	

- Evaluation of surge : ±4 kV(Power Line) / ±2 kV(Communication port)

Compliance

	Home 8	SE Box
Grid Code	IEEE1547, 1547.1, UL1741,UL1741SA, CA Rule21,IEEE2030.5-2018/ Sunspec CSIP	CA Rule 21, IEEE2030.5-2018/ Sunspec CSIP
Safety	UL1741, C22.2 No.107.1- 16,UL1642, UL1973, UL9540A	UL1741, C22.2 No.107.1-16
Functional Safety	IEC60730-1 Annex H	-
System Safety	UL9540	
Enclosure	NEMA Type 3R ⁷⁾	
EMC	FCC Part15 Subpart B	
Seismic	IEEE 693	

7) Tested by IEC60068-2-52

8) Visit : <https://www.lg.com/us/ess/warranty>

- Design and specifications are subject to change without notice.

Open Source Software Notice Information

To obtain the source code that is contained in this product, under GPL, LGPL, MPL, and other open source licenses that have the obligation to disclose source code, and to access all referred license terms, copyright notices and other relevant documents, please visit <https://opensource.lge.com>. LG Electronics will also provide open source code to you on CD-ROM for a charge covering the cost of performing such distribution (such as the cost of media, shipping, and handling) upon email request to opensource@lge.com. This offer is valid to anyone in receipt of this information for a period of three years after our last shipment of this product.

Compatible Eaton Parts

Eaton is a trade name, trademark, and/or service mark of Eaton Corporation plc, or its subsidiaries and affiliates.

LGEUS does not provide Eaton products.

Main Breakers

Eaton CSR 25 kAIC Breaker

Amps	Part Number	Description
100	CSR2100	Eaton CSR2100, 100A Main Breaker, 2-pole, 120/240V, 25kAIC
125	CSR2125N	Eaton CSR2125N, 125A Main Breaker, 2-pole, 120/240V, 25kAIC
150	CSR2150N	Eaton CSR2150N, 150A Main Breaker, 2-pole, 120/240V, 25kAIC
175	CSR2175N	Eaton CSR2175N, 175A Main Breaker, 2-pole, 120/240V, 25kAIC
200	CSR2200N	Eaton CSR2200N, 200A Main Breaker, 2-pole, 120/240V, 25kAIC

Eaton BW 10 kAIC Breaker

Amps	Part Number	Description
100	BW2100	Eaton BW2100, 100A Main Breaker, 2-Pole, 120/240V, 10kAIC
125	BW2125	Eaton BW2125, 125A Main Breaker, 2-Pole, 120/240V, 10kAIC
150	BW2150	Eaton BW2150, 150A Main Breaker, 2-Pole, 120/240V, 10kAIC
175	BW2175	Eaton BW2175, 175A Main Breaker, 2-Pole, 120/240V, 10kAIC
200	BW2200	Eaton BW2200, 200A Main Breaker, 2-Pole, 120/240V, 10kAIC

Circuit Breaker

Amps	Part Number	Description
15	BR215B	Eaton BR215B, 15A Circuit Breaker, 2-pole, 120/240V, 10kAIC
20	BR220B	Eaton BR220B, 20A Circuit Breaker, 2-pole, 120/240V, 10kAIC
30	BR230B	Eaton BR230B, 30A Circuit Breaker, 2-pole, 120/240V, 10kAIC
40	BR240B	Eaton BR240B, 40A Circuit Breaker, 2-pole, 120/240V, 10kAIC
50	BR250B	Eaton BR250B, 50A Circuit Breaker, 2-pole, 120/240V, 10kAIC
60	BR260	Eaton BR260, 60A Circuit Breaker, 2-pole, 120/240V, 10kAIC
70	BR270	Eaton BR270, 70A Circuit Breaker, 2-pole, 120/240V, 10kAIC
80	BR280	Eaton BR280, 80A Circuit Breaker, 2-pole, 120/240V, 10kAIC
90	BR290	Eaton BR290, 90A Circuit Breaker, 2-pole, 120/240V, 10kAIC
100	BR2100	Eaton BR2100, 100A Circuit Breaker, 2-pole, 120/240V, 10kAIC
110	BR2110	Eaton BR2110, 110A Circuit Breaker, 2-pole, 120/240V, 10kAIC
125	BR2125	Eaton BR2125, 125A Circuit Breaker, 2-pole, 120/240V, 10kAIC

Other Accessories

Part Number	Description
BRS225 / BRPSF225	225A/2-pole Main or Sub-feed lug block
BRHDK125 ¹⁾	Hold Down Kit for fixing BR series circuit breaker, if required

1) Compatible with BRHDK125 Hold-Down Kit to comply with 2017 NEC 710.15E for back-fed circuit breakers.

Multiple Home 8 Units or PV Inverters Connection

Dedicated circuit breakers are required when multiple power sources are connected to the SE Box to meet the NEC. The dedicated circuit breakers should be located in the SE Box or load center of the corresponding power source.

Do not connect any loads to the sub-panels of the PV or Home 8 or the internal panelboard in SE Box.

Total Ampacity of the Home 8 and PV Inverter is $\leq 200\text{A}$ (Whole Home Backup)

- 1) The total ampacity of the breakers for the Home 8 and PV inverter should not exceed the ampacity of the main breaker in the SE Box.
- 2) The ampacity of the main breaker in the backup panel should not exceed the ampacity of the main breaker in the SE Box.
- 3) It is recommended that the PV CT be located in the the SE Box.

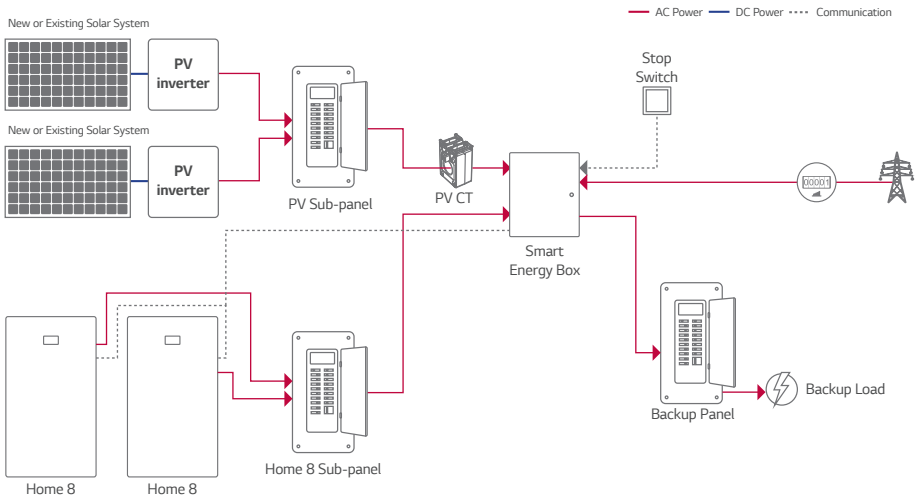

Total Ampacity of the Home 8 and PV Inverter is $\leq 200A$ (Partial Backup through the SE Box)

- 1) The total ampacity of the breakers for the Home 8 and PV inverter should not exceed the ampacity of the main breaker in the SE Box.
- 2) The sum of the ampacity of the main breaker in the backup panel and the ampacity of the main breaker in the non-backup panel should not exceed the ampacity of the main breaker in the SE Box.
- 3) It is recommended that the PV CT be located in the SE Box.
- 4) In this case, the power consumption by the non-backup loads can be measured by the internal site net CTs in the SE Box. Additional CTs are not required for site net metering.

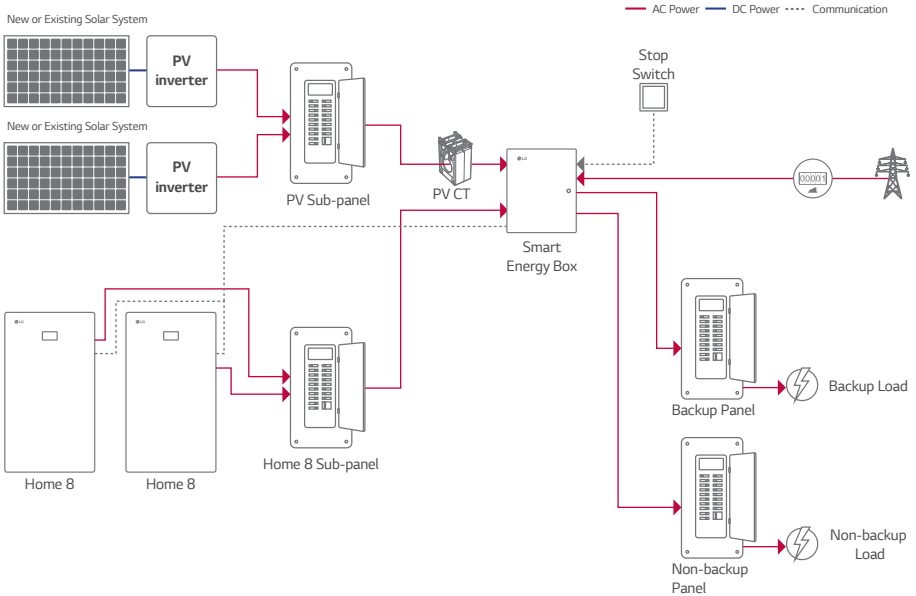

Total Ampacity of the Home 8 and PV Inverter is $\leq 200A$ (Partial Backup with the Main Panel)

- 1) The total ampacity of the breakers in the main panel should not exceed the ampacity of the main breaker in the main panel.
- 2) The total ampacity of the breakers for the Home 8 and PV inverter should not exceed the ampacity of the main breaker in the SE Box.
- 3) The ampacity of the main breaker in the backup panel should not exceed the ampacity of the main breaker in the SE Box.
- 4) It is recommended that the PV CT be located in the SE Box.
- 5) In this case, external CTs are required to measure the site net metering. The additional CTs can be purchased from LGEUS, and the installers must prepare these CTs ahead of the installations. CTs not supplied from LGEUS may give the wrong measured value for site net metering.
- 6) The energy meter in the SE Box can measure up to 400A ($2 \times 200A$ CT). If the service ampacity is greater than 200A, $2 \times 200A$ CTs are required to measure the site net metering. For example, in the case of 400A service, two 200A breakers are used in the service equipment. Then 2 sets of external site net CTs are Required. Follow the instruction guide on external CT installation.

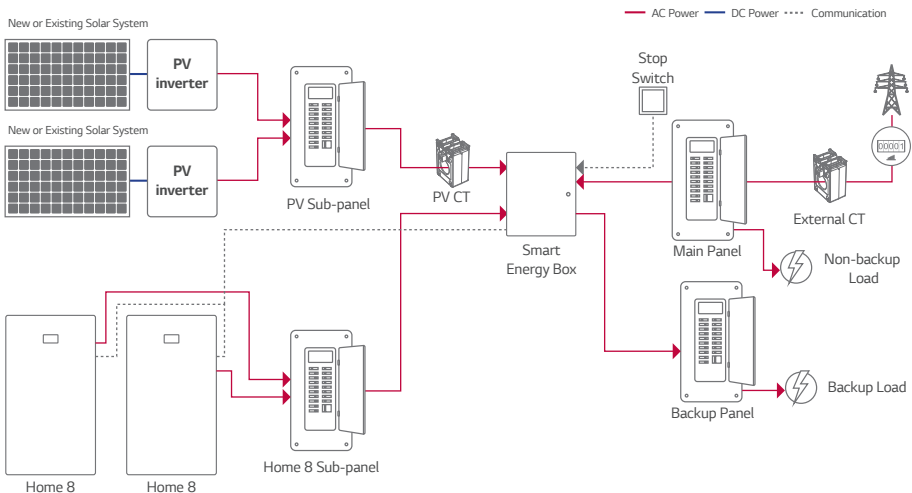

Total Ampacity of the Home 8 and PV Inverter is $\leq 200A$ (Partial Backup with the Non-Backup Panel located Upstream of the SE Box)

- 1) The sum of the ampacity of the main breaker in the SE Box and the ampacity of the main breaker in the non-backup panel should not exceed the service ampacity.
- 2) The total ampacity of the breakers for the Home 8 and PV inverter should not exceed the ampacity of the main breaker in the SE Box.
- 3) The ampacity of the main breaker in the backup panel should not exceed the ampacity of the main breaker in the SE Box.
- 4) It is recommended that the PV CT be located in the SE Box.
- 5) In this case, external CTs are required to measure the site net metering. The additional CTs can be purchased from LGEUS, and the installers must prepare these CTs ahead of the installation. CTs not supplied from LGEUS may give the wrong measured value for site net metering.
- 6) The energy meter in the SE Box can measure up to 400A (2 x 200A CT). If the service ampacity is greater than 200A, 2 x 200A CTs are required to measure the site net metering. For example, in the case of 400A service, two 200A breakers are used in the service equipment. Then 2 sets of external site net CTs are required. Follow the instruction guide on external CT installation.
 - i) Under 200A service
 - Option 1) Use 1 set of external CTs to measure the site net power. The connector of the internal site net CT should be removed in the SE Box.
 - Option 2) Use 1 set of external CTs to measure the non-backup loads. In this case, do not remove the connector of the internal site net CTs. The measured value of the external CTs is added to that of the internal CTs.
 - ii) Over 200A service.

In general, the max ampacity of the main breakers is 200A at the residential size. One can be used as the dedicated breaker for the SE Box and the other can be used as the non-backup load. In this case, only 1 set of external CTs is required for the dedicated breaker for the non-backup load.

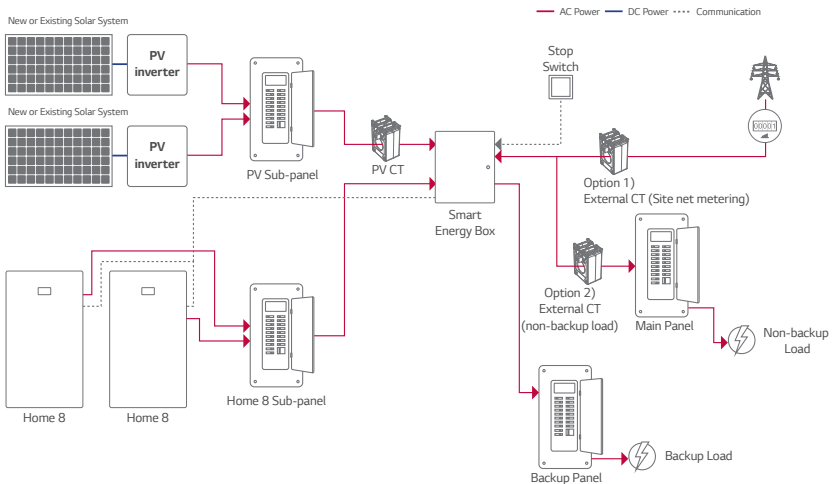

Total Ampacity of the Home 8 and PV Inverter is > 200A (Whole Home Backup)

The Home 8 load center and PV load center require main breakers in their load centers. Also, another dedicated circuit breaker for the 2 load centers is required and should be located between the SE Box and the two load centers. The lug kit is only supported in the SE Box, not in this breaker.

- 1) The total ampacity of the breakers for the Home 8 should not exceed the ampacity of the main breaker in the SE Box and the ampacity of the breaker in the "A" panel.
- 2) The total ampacity of the breakers for the PV should not exceed the ampacity of the main breaker in the SE Box and the ampacity of the main breaker of the Home 8 load center for stable back up operation and the ampacity of the breaker in the "A" panel.
- 3) The ampacity of the breaker in the "A" panel should not exceed the ampacity of the main breaker in the SE Box.
- 4) The ampacity of the main breaker in the backup panel should not exceed the ampacity of the main breaker in the SE Box.
- 5) With any of the above cases, the PV CT should not be located in the SE Box. Extended cables for the PV CT may be required depending on the installation conditions.

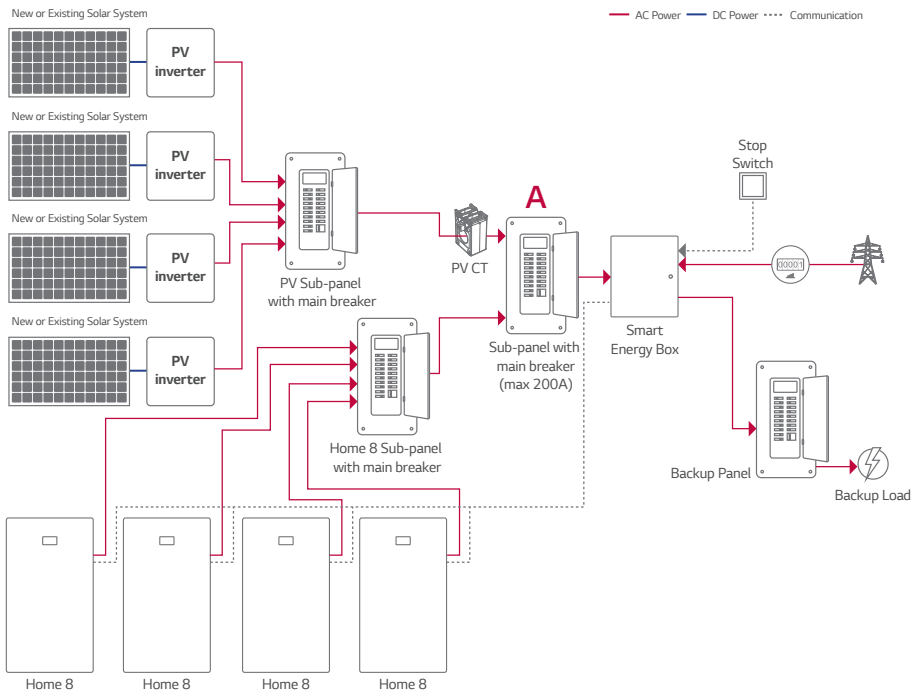

Total Ampacity of Home 8 and PV Inverter is > 200A (Partial Backup)

The Home 8 load center and PV load center require main breakers in their load centers. Also, another dedicated circuit breaker for the 2 load centers is required and should be located between the SE Box and the two load centers. The lug kit is only supported in the SE Box, not in this breaker.

- 1) The total ampacity of the breakers for the Home 8 should not exceed the ampacity of the main breaker in the SE Box and the ampacity of the breaker in the "A" panel.
- 2) The total ampacity of the breakers for the PV should not exceed the ampacity of the main breaker in the SE Box and the ampacity of the main breaker of the Home 8 load center for stable backup operation and the ampacity of the breaker in the "A" panel.
- 3) The ampacity of the breaker in the "A" panel should not exceed the ampacity of the main breaker in the SE Box.
- 4) The ampacity of the main breaker in the backup panel should not exceed the ampacity of the main breaker in the SE Box.
- 5) With any of the above cases, the PV CT should not be located in the SE Box. Extended cables for the PV CT may be required depending on the installation conditions.
- 6) In the event there is greater than 200A service capacity, the B panel should have two different main breakers. One would be the dedicated circuit breaker for the SE Box and the other would be the dedicated circuit breaker for the non-backup load. The energy meter integrated in the SE Box supports 400A (2 x 200A CT) measurement. In this case, external CTs are required to measure the non-backup load. (Do not remove the connector of the internal site net CTs.) The measured value of external CTs are added to that of the internal CTs.

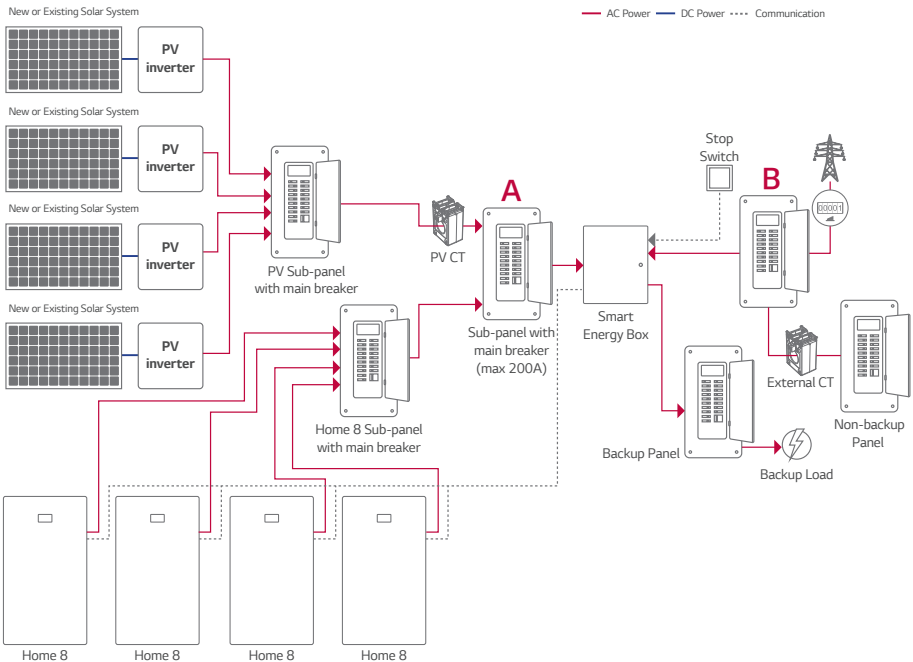

Usage of External CTs

If the SE Box is unable to measure all house loads under the on-grid status, external site net CTs must be connected to the energy meter inside the SE Box.

Internal CTs measure the whole current flown into the grid port inside the SE Box, including non-backup loads connected with the SE Box. According to the site configuration, there are 2 options for site net measurement by using external CTs. (Please label L1 and L2 at the end of the cables to prevent them from being switched or use two different cable colors.)

The energy meter inside the SE Box supports a total of 400A (2 x 200A).

With Internal CTs

When adding the current measured by the external CTs to the internal CT measurement is required, external CTs are used with the internal CTs. Connect the external CT cable to the external CT connector by using a 4-position terminal block.

Without Internal CTs

If the current is double-measured due to the placement of the external CTs, the internal CTs should be disconnected.

- i) Remove the CT L1, CT L2 connectors from the SE Box.
- ii) Insulate the internal CT connectors.
- iii) Connect the external CTs as a twisted pair to the external CT connector.

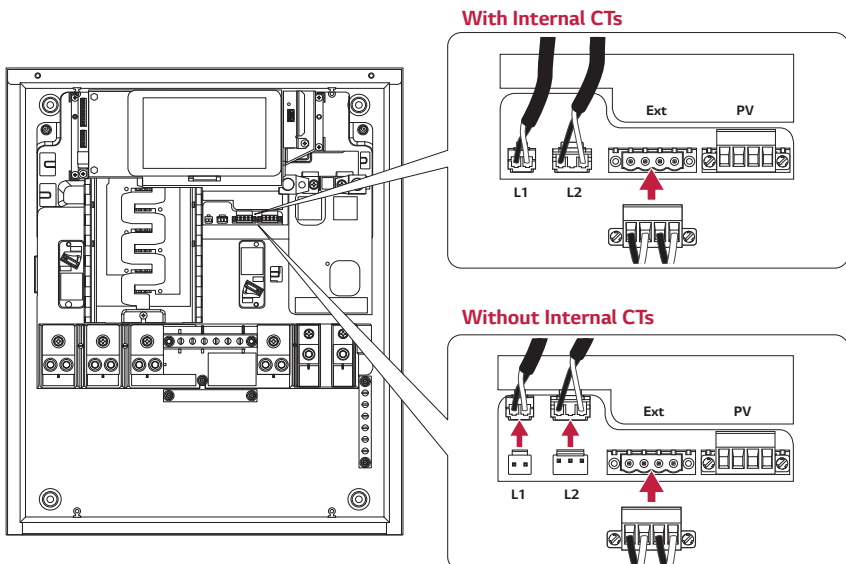

External CT Direction

Pass the L1 and L2 cables through 200A CT as shown below.

The side with the markings P1 and K showing on both CTs (L1,L2) shall face the utility grid (the primary power source). In this case, longer cables for the CTs are required for connection to the SE Box.

- L1 - S1: Black (Ext CT L1+), S2: White (Ext CT L1-)
- L2 - S1: Red (Ext CT L2+), S2: White (Ext CT L2-)
- Ring terminal: stud size - 1/4 inch, wire range – min. 18AWG
- Twist the S1 and S2 cables together.

Use the sealable covers included in the CT packaging box to protect the screw terminals to always assure the best safety. Refer to manual included in the CT package to assemble the sealable covers.

Do not connect the L1 CT cable to the L2 position in the terminal block (vice versa).

For detailed information on cable extension, refer to the "Extending CT Cable Length".

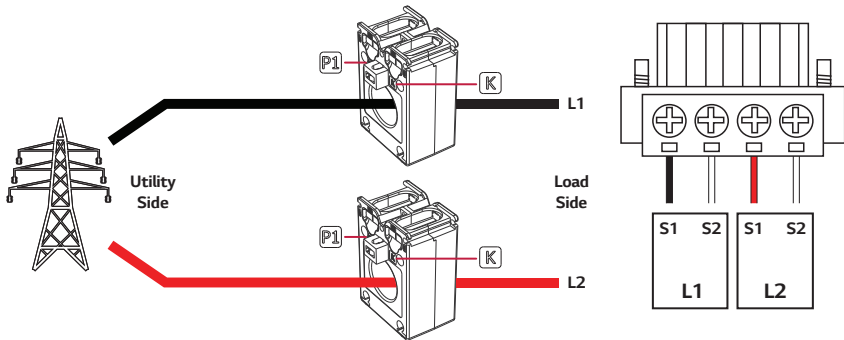

INFO

Make sure the CTs are facing the proper direction as described in this manual. A CT will show a negative value if installed backwards.



CAUTION

- Make sure the CT sensor's direction is correct.
- If required, fix the CTs to the cables with a cable tie.

Multiple Connection ID Setup Method

When setting up multiple Home 8 units, the PCS Address dip switch and Termination Resistors dip switch settings should be as follows. After the DIP switch settings, you must check the CAN communication between the Home 8 and SE Box.

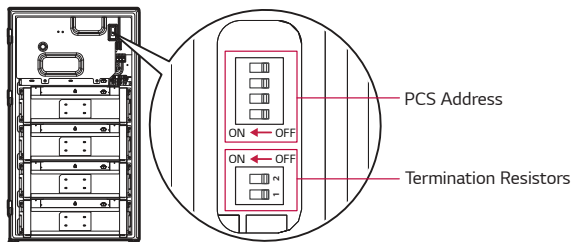

Multiple Home 8 (4 EA)

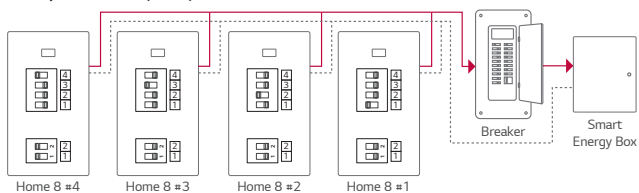

Multiple Home 8 (3 EA)

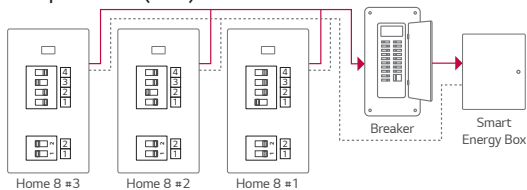

Multiple Home 8 (2 EA)

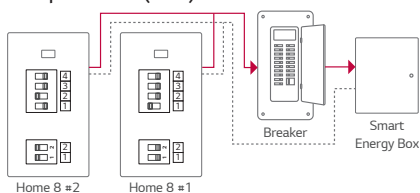

Single Home 8

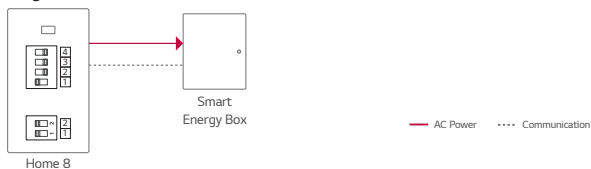

Communication Connections In Multiple Installation

A drain wire must be grounded in each Home 8 in the daisy-chain connection. For each pair of components, the drain wire is cut at the first component and grounded at the second.

(SE Box and the first Home 8, the first Home 8 and second Home 8)

The total length of the communication cables, including daisy-chained connections, should not be over 30 m from the SE Box to the last Home 8.

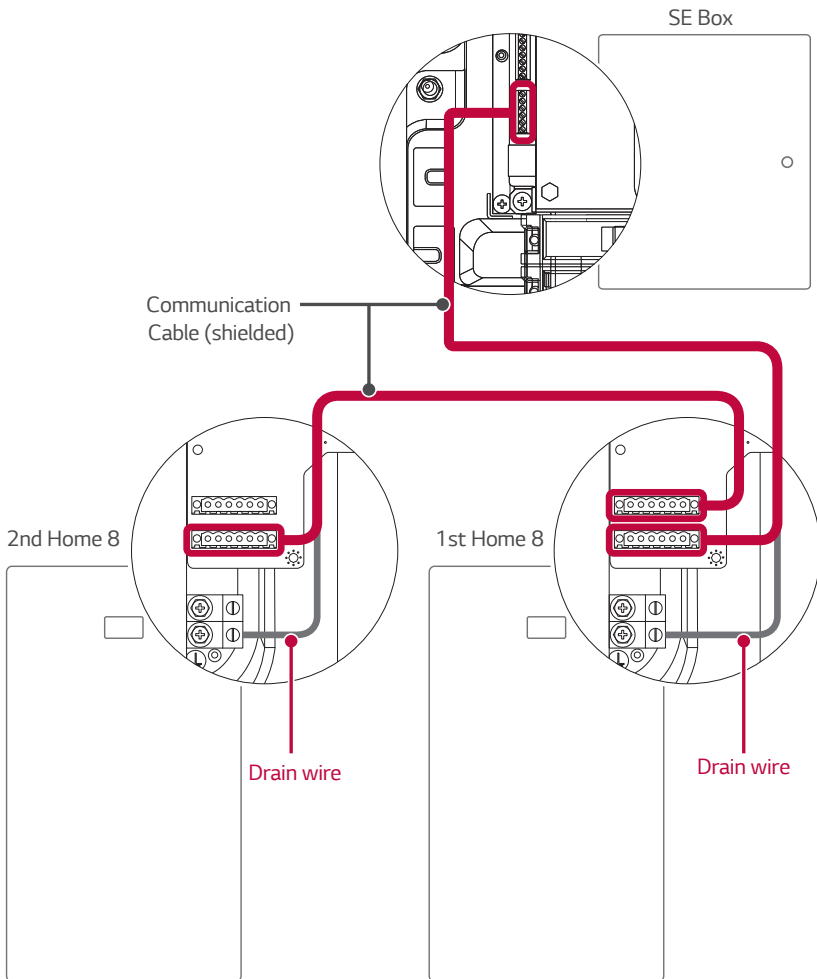

Battery Pack Disassembly Guide

WARNING

Be careful to avoid injury when cutting the package.

1

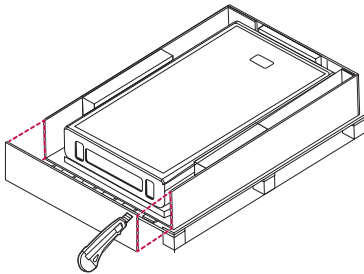

Cut the bottom of the package.

WARNING

- When working on the Home 8, at least 2 people are needed for safe installation and moving. the Home 8 is very heavy.
- Lift up the Home 8 far enough that the Bracket Connected Parts are not caught on the bottom block of the box when moving the bottom side.
- Be careful not to let the Home 8 fall over when standing the product up.
- When standing the Home 8 upright, make sure that the Legs touch the floor first. If the enclosure touches floor first, the product may slip which could lead to damage to the product or personal injury.

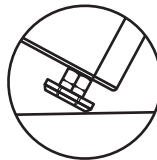

2

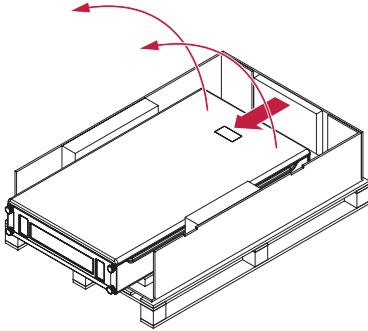

Move the Home 8 to stand on the bottom side by lifting the top of the product while the Home 8 Legs are out of the pallet, then stand the Home 8 upright.

CAUTION

- Be careful not to damage the Home 8 when opening the front cover. The Home 8 tilts forward when you open the door.
- The cut-out part at the bottom of the box can be used to prevent scratches by inserting it underneath the front cover when opening the front cover.

3

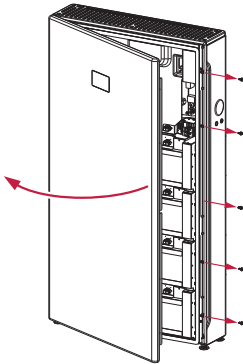

Remove the screws on the right side on the front cover starting from the bottom and working your way up, and then open the front door of the Home 8.

WARNING

High voltage is energized through the battery packs and battery power cable. Special care must be taken when disassembling.

- 4 Disassemble the Battery Power Cable and Battery Communication Cable.

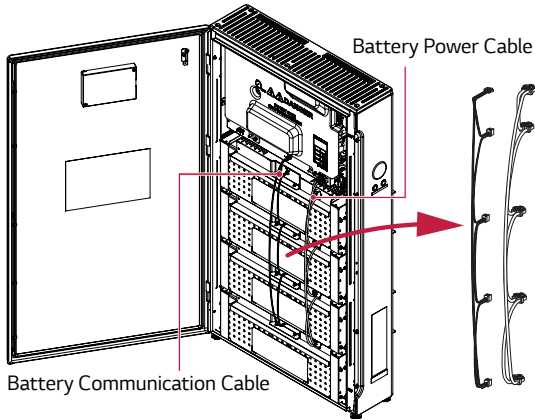

CAUTION

- Use a magnetic wrench for nut removal.
- Be careful to avoid injury when disassembling and assembling the battery packs. The battery packs are very heavy.
- One person must hold the back of the Home 8 while disassembling the battery packs to prevent the product from falling down.

- 5 Unscrew the 14 M6 nuts on the battery packs. 4 nuts are used on each upper pack, and 2 nuts are used on the bottom pack.
- 6 Disassemble the 4 battery packs starting with the top packs and working down to the bottom pack.

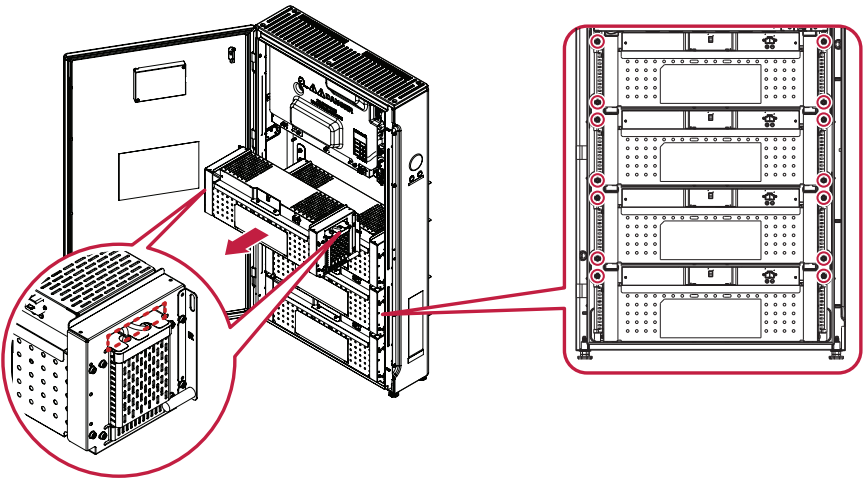

WARNING

When working on the Home 8, at least 2 people are needed for safe installation and moving.

- 7 Close the front cover and hang the Home 8 on the wall bracket. Next, rotate the legs to bring the Home 8 level with the floor.

WARNING

When assembling the battery power cable and the battery communication cable, connect the cables until you hear a “click” sound and make sure that the connectors do not come off easily when you pull on them lightly.

- 8 Assemble the battery packs in the reverse order of disassembly.

Wiring Diagram

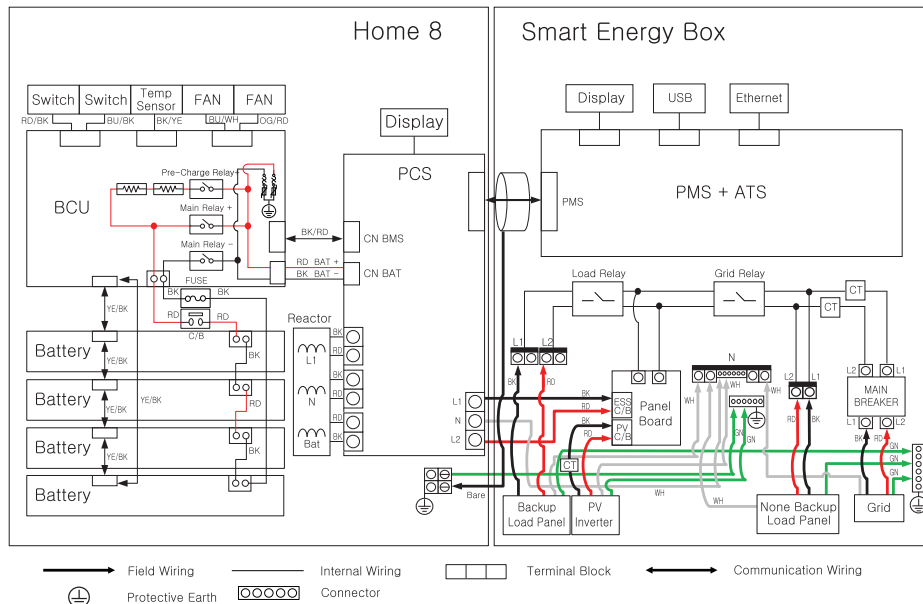



LG Electronics ESS Service

ATTN: Electro-Tech Services, Inc.
19481 SAN JOSE AVE. CITY OF INDUSTRY CA 91748
Tel.: (833) 940-5010
E-mail: esssvc.lge@etssi.com

LG Electronics USA, Inc.
111 Sylvan Avenue North Building Englewood Cliffs,
NJ 07632 USA

LG Customer Information Center

1-888-865-3026

Register your product online!

<https://www.lg.com/us/ess>