



MNHAWKE'S BAY BB125 Manual

Hawke's Bay Breaker Box Owner's Manual





MNHAWKE'S BAY BB125 Manual

Table of Contents

Introduction	3
Safety Instructions	4
Battery Safety	5
How to KILL Your Batteries	6
Wiring Requirements	7
DC Wiring.....	8
DC Over-Current Protection	9
Grounding.....	9
Installation	10
Mounting Location	10
Mounting Hawke's Bay and Breaker Box WITH Backplate	10
Mounting Hawke's Bay and Beaker Box WITHOUT Backplate	11
Hawke's Bay and Breaker Box Wiring	12
Pre-Installed Wiring.....	13
External Wiring.....	14
Energizing the Hawke's Bay Breaker Box	16
Technical Drawings	17
Warranty	21

This entire manual is printed without color but is available for download—with many of the diagrams available in color—on our website at midnitesolar.com.



MNHAWKE'S BAY BB125 Manual

INTRODUCTION

The Hawke's Bay BB125 Breaker Box is a DC enclosure offering over-current protection (OCP) and disconnects between the PV array input to a charge controller, and OCP and disconnect from the charge controller to the battery bank. The Breaker Box is designed specifically for the MidNite Solar Hawke's Bay 600V MPPT charge controller but may be used with any charge controller up to 600VDC/30A IN and 80VDC/125A out. The Hawke's Bay charge controller will operate WITHOUT the optional Breaker Box.

Standard Features:

- 600VDC, 30A, 2-pole, PV input circuit breaker with Remote-trip
- 80VDC, 125A, battery positive circuit breaker
- Terminal block to attach an optional MidNite Solar Surge Protection Device
- Styled to match the Hawke's Bay 600V MPPT Charge Controller
- Optional backplate for mounting
- Ground busbar
- ETL Listed



Pre-Wired Hawke's Bay and Breaker Box ...
Includes PV and Battery breakers, SPDs (not shown), and mounting backplate.



IMPORTANT SAFETY INSTRUCTIONS SAVE THESE INSTRUCTIONS

THIS MANUAL CONTAINS IMPORTANT INSTRUCTIONS FOR THE MIDNITE SOLAR HAWKE'S BAY BREAKER BOX THAT SHALL BE FOLLOWED DURING INSTALLATION AND OPERATION.

If you do not fully understand any of the concepts, terminology, or hazards outlined in these instructions, please refer installation to a qualified dealer, electrician, or installer. These instructions are not meant to be a complete explanation of a renewable energy system. Before using the Hawke's Bay Breaker Box, read all instructions and cautionary markings. The installation instructions are for use by qualified personnel only. Do not perform any installation other than that specified in this manual unless you are qualified to do so. Incorrect installation may result in a risk of electric shock, fire, or other safety hazard.

Safety Symbols

The following safety symbols have been placed throughout this manual to indicate dangerous and important safety instructions.

WARNING!

WARNING indicates a hazardous situation which, if not avoided, could result in death or serious injury.

CAUTION!

CAUTION indicates conditions or practices that could result in damage to the unit or other equipment.

INFO: Indicates information that emphasizes or supplements important points of the main text.

SAFETY PRECAUTIONS

- System grounding is the responsibility of the system installer and must comply with local and national electrical codes and standards.
- This product is designed for indoor/compartments installation. It must not be exposed to rain, snow, moisture, or liquids of any type.



MNHAWKE'S BAY BB125 Manual

- Listed or labeled equipment shall be installed and used in accordance with any instructions included in the listing or labeling.
- Over-current protection of the DC wiring must be provided as part of the system installation.
- All electrical work must be performed in accordance with local and national electrical codes.
- Use insulated tools to reduce the chance of electrical shock or accidental short circuits.
- Use Class 1 wiring methods for field wiring connections to terminals of a Class 2 circuit.
 - Hawke's Bay Class 2 terminals: WBJr, AUX, Current Transformers, BTS, CANBUS.
 - Hawke's Bay Breaker Box Class 2 terminals: None.
- The DC negative conductors are not connected (bonded) to the Hawke's Bay chassis.
- Always verify proper wiring prior to energizing the Hawke's Bay and Breaker Box.
- Torque all wiring and cable connections to the required torque values.
- Use only copper wires with a minimum temperature rating of 90°C.
- Properly mount the Hawke's Bay and Breaker Box.
- Battery cables should be no less than **#2 AWG**.

BATTERY SAFETY

- Wear eye protection and avoid touching your eyes and face when working with batteries to keep any fluid/corrosion on the battery from contact with eyes and skin. Have plenty of fresh water and soap nearby and thoroughly wash in case battery acid contacts skin, clothing, or eyes. In the event of exposure to the eyes, flood them for at least 15 minutes with running water and seek immediate medical attention. Baking soda neutralizes lead acid battery electrolyte and vinegar neutralizes spilled NiCad and NiFe battery electrolyte; depending on your battery type, keep a supply on hand near the batteries.
- Read and follow the battery manufacturer's safety precautions before installing the inverter and batteries. Always verify proper polarity and voltage before connecting the batteries to the Hawke's Bay and Breaker Box. Once the batteries are connected, ensure the maintenance and charging requirements (i.e., charge voltage and charge rate) provided by the battery manufacturer are followed to extend the life of the batteries and to prevent damage to the batteries while charging.
- The battery bank should be installed in a clean, dry, ventilated environment that is protected from high and low temperatures. If installed in a vehicle/boat, the batteries must be mounted upright (if using liquid batteries) and securely fastened. The location must be fully accessible and protected from exposure to heat producing devices, and away from any fuel tanks.
- Batteries can produce explosive gasses, so install batteries in a well-ventilated area. For compartment or enclosure installations, always vent batteries from the highest point to the outside. Design the battery enclosure to prevent accumulation and concentration of hydrogen gas in pockets at the top of the compartment.



MNHAWKE'S BAY BB125 Manual

- Remove all jewelry such as rings, watches, bracelets, etc., when installing or performing maintenance on the batteries and inverter. A battery can produce a short-circuit current high enough to weld metal jewelry, causing severe burns.
- Use insulated tools and be very careful when working around batteries, they can produce extremely high currents if short-circuited (e.g., dropping a metal tool across the battery terminal), which could cause a fire or explosion.
- To prevent a spark at the battery and to reduce the chance of explosion, turn off (open) the DC battery breaker before attempting any wiring connections.
- Never work alone. Always have someone within the range of your voice or close enough to come to your aid when working around batteries.
- Never use old or untested batteries. Check each battery's label for age, type, and date code to ensure all batteries are identical.
- Batteries are sensitive to changes in temperature. Install batteries in a stable environment.
- Provide at least one inch of air space between batteries to provide optimum cooling.
- Use proper lifting techniques when working with batteries.
- Never smoke or allow a spark near batteries.
- Never charge a frozen battery.

STANDARDS

The MidNite Solar Hawke's Bay Breaker Box conforms to *UL 1741, Safety for Inverters, Converters, Controllers and Interconnection System Equipment for Use with Distributed Energy Resources, UL 1741:2010 Ed.2+R:15Feb2018; CSA C22.2#107.1:2016 Ed.4.*

HOW TO **KILL** YOUR BATTERIES

Batteries are delicate and require proper attention, especially when off-grid. Think of your batteries and solar equipment as a small nuclear power plant, hydro dam, or natural gas-fired power plant. Just like any of those, your system needs DAILY attention to ensure it is performing correctly and safely. We recommend the use of an independent battery monitor/alarm if you have an expensive battery bank. Below is a list of some of the most common ways we have seen people kill their battery bank.

- Using more than three parallel strings and not using common bus bars. With lead-acid batteries, when you use more than three strings, it is very hard to properly charge the middle strings. The only safe way to do this is to wire each string with equal length cables to a common bus bar. Connect inverter cables to the farthest points on the busbars.
- Not watching to verify the Absorb or EQ times are set properly and that the equipment actually charges for that period of time. Some equipment will have settings like "End Amps" that can terminate Absorb early and, if set up wrong, can damage a battery.
- Not using ALL EQUAL LENGTH interconnect cables on each string. It is important that ALL strings be wired EXACTLY the same. Any variance in resistance on one string versus another



MNHAWKE'S BAY BB125 Manual

will cause an imbalance and the batteries will suffer a shortened lifespan.

- Trusting a State of Charge (SOC) meter, which can lose calibration over time and give you false readings. You need to verify specific gravity and or verify the charge voltage is being met. Never fully rely on the SOC %; it is just a good, quick reference.
- Routinely using more than 50% of the capacity of the lead acid battery. Using more than half the battery capacity drastically shortens the batteries life; occasionally is fine, but daily will kill lead acid batteries in months.
- Not leaving ample space between cells for cooling. We recommend at least one inch between the cells for cooling. Ask the battery manufacturer what they recommend.
- Not having enough charge current to properly charge the size of the battery you have. Consult the battery manufacturer for the minimum charge current.
- Using tap water or other liquids instead of distilled water in a flooded battery. The minerals in the tap water will destroy a battery.
- Not verifying the temperature compensation neutral point (typically 25°C) and the milli volts per degree C per cell (typically -5mV).
- Not verifying you are charging to the voltage supplied by the battery manufacturer.
- Not fully charging your lead acid batteries at least once a week.
- Failing to keep all connections clean.

WIRING REQUIREMENTS

- The NEC (*National Electric Code, ANSI/NFPA 70*) for the United States and the CEC (*Canadian Electrical Code*) for Canada provide standards for safely wiring residential and commercial installations. The NEC/CEC lists the requirements for wire size, over-current protection, and installation methods.
- Do not mix AC and DC wiring in the same panel unless specifically approved/designed for both AC and DC wiring. Where DC wiring must cross AC or vice-versa, try to make the wires at the crossing point perpendicular (90 degrees) to one another.
- DC wires to and from the Hawke's Bay must be protected as required by code. This can be done by using jacketed wires or by feeding the wires through conduit or a conduit box. The Hawke's Bay Breaker Box satisfies this requirement.
- Always check for existing electrical, plumbing, or other areas of potential damage prior to making cuts in structural surfaces or walls.
- Wiring should meet all local codes and standards and be performed by qualified personnel such as a licensed electrician.
- DC over-current protection must be provided as part of the installation.
- Use only copper wires with a minimum temperature rating of 90°C.
- The equipment ground is marked with this symbol: 



MNHAWKE'S BAY BB125 Manual

CAUTION!

The Hawke's Bay and Breaker Box are designed for indoor installation with adequate ventilation. It must not be exposed to rain and should be installed out of direct sunlight.

WARNING!

Ensure all sources of DC power (i.e., batteries, solar, wind, or hydro) are **OFF** – breakers opened, fuses removed – before proceeding to prevent accidental shock.

DC Wiring

- Minimize the number of connections between the Hawke's Bay, the Breaker Box, and the battery bank. Exceptions are the DC breaker —required at the battery to protect the DC wiring—in the positive line, and a DC shunt—to allow battery charge state monitoring—in the negative line. Additional connections will contribute to voltage drops, and these extra connection points may loosen during use.
- The DC cables/wires must be color coded with colored tape or heat shrink tubing: RED for positive (+); WHITE for negative (-) if solidly grounded or BLACK if using a GFP breaker; and GREEN for DC ground.
- Use the correct DC cable and corresponding circuit breaker to achieve maximum efficiency from the system and reduce fire hazards associated with overheating.
- The DC cables must be fine strand, super flexible, such as Cobra cable (or equivalent) and be approved for residential wiring per the NEC (THHN for example).
- Do not use the Hawke's Bay chassis in place of the battery negative connection for grounding. A reliable return path directly to the battery is required.
- A readily accessible battery disconnect is required and must be located within sight of the battery system (NEC 480.7).
- Ensure cables have a smooth bend radius and do not become kinked. Follow existing wire runs where possible.
- Ensure both DC cables pass through the same knockout and conduit to allow the inductive currents to cancel.
- Wiring to battery terminals should be checked once a month for proper tightness.
- Limit cable length to 6' or less from Hawke's Bay Breaker Box to battery bank.
- **The battery bank voltage MUST be 48V!** Use **#2 AWG** (or larger) battery cables.



MNHAWKE'S BAY BB125 Manual

DC Over-Current Protection

- The NEC requires both over-current protection (UL489 standards) and a disconnect switch. If a circuit breaker is used as the over-current protection device, it can also be used as the required DC disconnect.
- The DC over-current protection device must be installed on the positive DC cable. It must be correctly sized according to the size of DC cables being used, which means it is required to open before the cable reaches its maximum current carrying capability.

Grounding

- The negative battery conductor should be solidly bonded to the grounding system at only one point in the system. The size for the conductor is determined by the size of the largest phase conductor, per the NEC/CEC.

NOTE – If using the optional ground fault (GF) toroid in the Hawke's Bay, the battery can be solidly grounded.

- **Figure 1** shows the Hawke's Bay equipment ground terminal.
- **Figure 5** shows the Ground busbar in the Breaker Box.
- Use **#6 AWG** Ground Electrode Conductor.



Figure 1

CAUTION!

The Hawke's Bay may be used in a positive, negative, or ungrounded installation. For a grounded system, bond either Battery Negative to Ground, or bond Battery Positive to Ground (but not both at the same time!!).

Arc Fault - The NEC requires any PV system DC circuit operating at 80VDC or greater must be protected by an arc fault (AF) circuit interrupter.

Ground Fault - Since 2008 the NEC requires a DC Ground Fault (GF) Protection device on all PV systems to indicate when a GF condition exists.

Installations should be performed by a licensed or certified electrician. It is the installer's responsibility to determine which safety codes apply.



MNHAWKE'S BAY BB125 Manual

INSTALLATION

Before installing, read the entire installation section to determine how you are going to install your Hawke's Bay and Breaker Box. The more thoroughly you plan in the beginning, the better your overall system needs will be met.

The installation begins by selecting a wall. The Hawke's Bay and Breaker Box are indoor rated and should not be placed outside unless precautions are made to keep rain and moisture off the system.

The NEC requires 30" clear on the wall. The Hawke's Bay and Breaker Box may be located anywhere within this 30". The NEC also requires 36" free and clear of obstructions in front of the charge controller. The 36" clear area in front of all electrical panels is to provide a space to fall back into in case of electrical shock.

Mounting Location

Install the Hawke's Bay and Breaker Box in a location that meets the following requirements:

- Locate the Hawke's Bay and Breaker Box as close to the batteries as possible. Long DC wires tend to lose efficiency and reduce the overall performance. However, the Hawke's Bay should not be mounted where it will be exposed to gases produced by the batteries. Gases are corrosive and will damage the controller; also, if gases are not ventilated and if allowed to collect, they could ignite and cause an explosion.
- Ensure the Hawke's Bay is accessible after it is mounted. Control buttons are located on the front of the unit. You will need to access these buttons to program and monitor its operation.
- The Hawke's Bay weighs 23 pounds. The Breaker Box weighs 10.2 pounds. The mounting surface and hardware must be capable of supporting at least twice the weight of these components.
- Mount at least 2' from any flammable or combustible fluid or components (i.e., paper, cloth, plastic, etc.) that may be ignited by heat, sparks, or flames.
- The area must be free from any risk of condensation, water, or any other liquid that can enter or fall on the Hawke's Bay or Breaker Box.
- Mounted vertically on a flat, non-combustible surface.
- Plan any conduit runs now.

Mounting – Hawke's Bay and Breaker Box with Backplate

1. The optional backplate (**Figure 2**) makes installation easier.
2. Place backplate on wall at mounting location.
3. Mark holes for mounting hardware to hold backplate to wall.



Figure 2



MNHAWKE'S BAY BB125 Manual

4. Pre-drill pilot holes.
5. Lay backplate on workbench; attach Hawke's Bay to backplate, aligning the keyholes (**Figure 3**) to the studs on the backplate; slide down into locking position.
6. Attach Breaker Box below Hawke's Bay, aligning keyholes.
7. Wire Hawke's Bay to the Breaker Box now (Page 12).
8. Mount the assembly to the wall using lag bolts.
9. Ensure mounting hardware is sufficient for the weight of the assembly and the mounting surface material.



Figure 3

Mounting – Hawke's Bay and Breaker Box without Backplate

1. Place Hawke's Bay on wall at mounting location.
2. Mark holes for mounting hardware to hold Hawke's Bay to wall.
3. Pre-drill pilot holes.
4. Based on mounting hardware, either:
 - a. Hold Hawke's Bay to wall and install mounting hardware through the keyholes;
 - b. **Or** install top two mounting hardware bolts, then attach Hawke's Bay, then install bottom two bolts.
 - c. Secure mounting hardware.
5. Repeat for Breaker Box:
 - a. Hold Breaker Box below Hawke's Bay, be careful of pre-attached wires and busbars.
 - b. Ensure the Breaker Box is fully mated to the Hawke's Bay.
 - c. Mark for holes, pre-drill.
 - d. Install mounting hardware and secure.
6. Ensure mounting hardware is sufficient for the weight of the assembly and the mounting surface material.



Be careful of the pre-installed wires when mating the Hawke's Bay to the Breaker Box.

HAWKE'S BAY & BREAKER BOX WIRING (Figures 4, 5, 6, 7, 8, 9, & 10)

Reference **Figure 4** for an overview of a wired Hawke's Bay and Breaker Box. **Figure 5** shows the pre-wired Hawke's Bay Breaker Box.

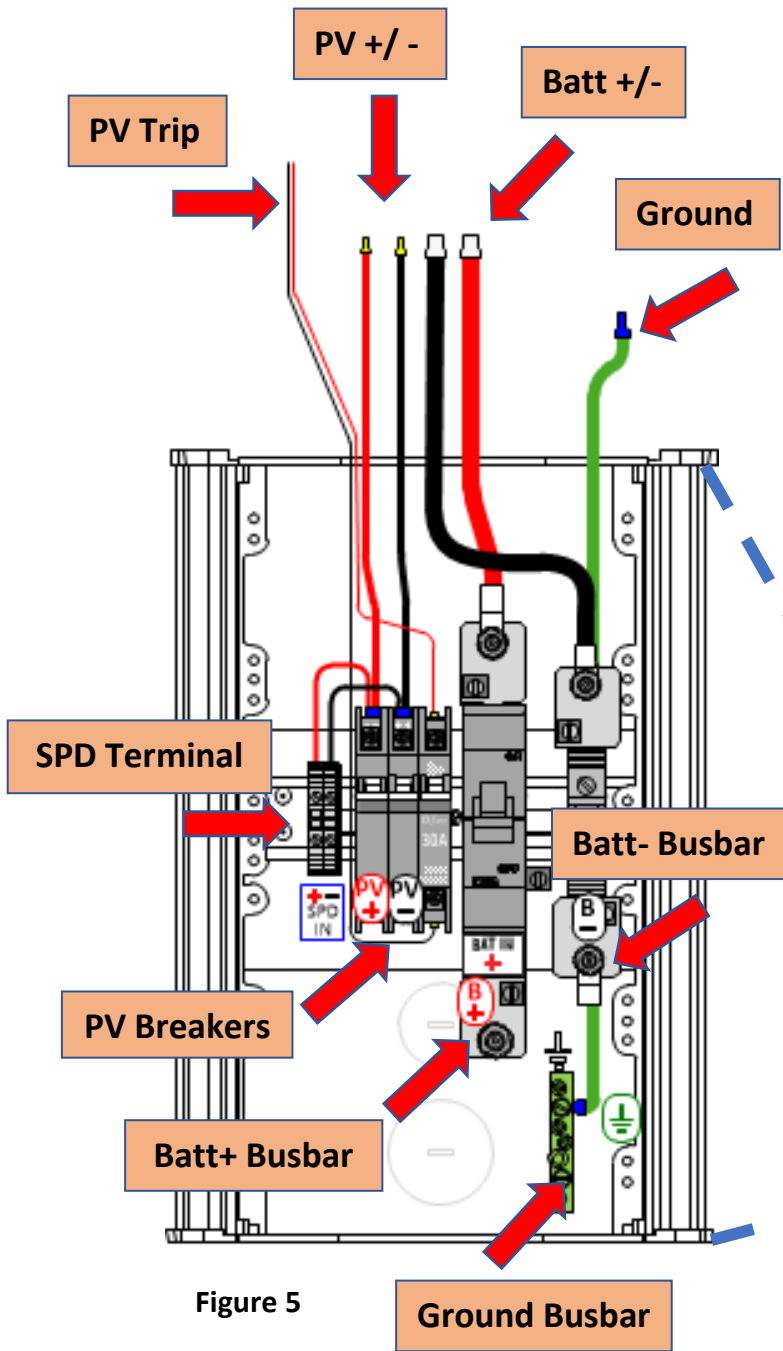

Figure 5

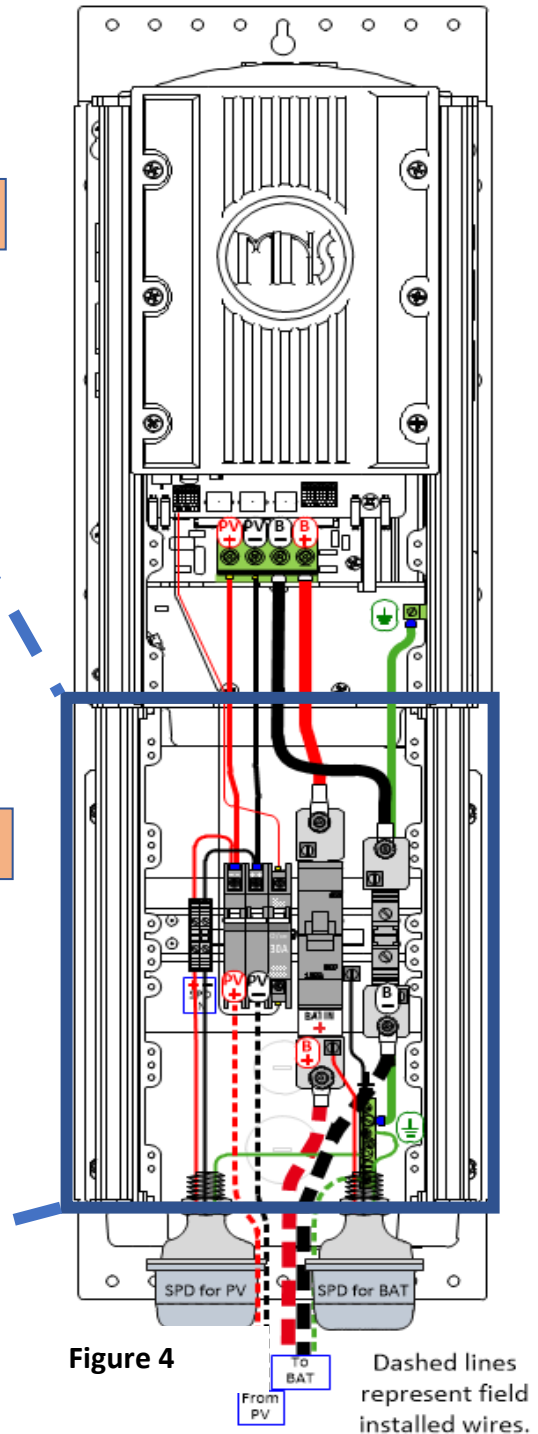

Figure 4



MNHAWKE'S BAY BB125 Manual

Pre-Installed Wiring (Figures 4, 5, 6, 7, & 8)

PV Breaker Trip Wires (Figures 6 & 8)

1. Ensure all breakers are off (down).
2. Raise the Hawke's Bay terminal block clamp levers (#1) marked "Breaker Trip."
3. Insert PV trip wires (#3) from PV input breaker into terminal block (#1). The terminal block has 3 ports, each marked with "+" and "-." You can use any 1 of the 3 terminals. Insert red wire to PV+ terminal; black wire to PV- terminal.
4. Securely fasten by pushing down on the block clamp levers.

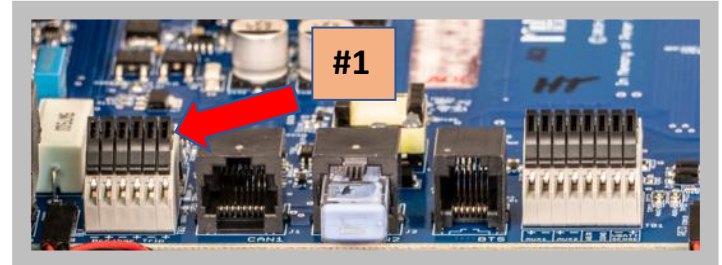

Figure 6

PV Wires (Figures 7 & 8)

1. Ensure all breakers are off (down).
2. Insert red PV+ wire (#4) into terminal block (#2).
 - a. Left setscrews = PV+ and PV-
 - b. Right setscrews = Batt+ and Batt-
3. Insert black PV- wire (#5) into terminal block (#2).
4. Torque to 22-39 in-lbs.

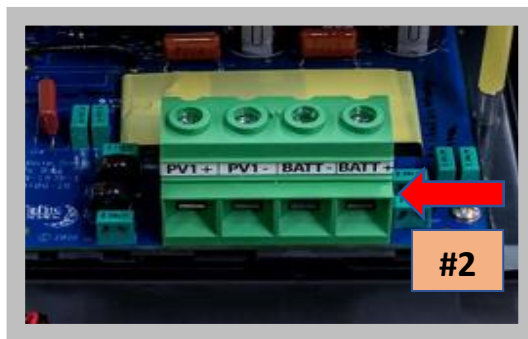

Figure 7

Battery Cables (Figures 7 & 8)

1. Ensure all breakers are off (down).
2. Attach Batt+ cable (#7) to Hawke's Bay Batt+ terminal (#2).
 - a. Left setscrews = PV+ and PV-
 - b. Right setscrews = Batt+ and Batt-
3. Attach Batt- cable (#6) to Hawke's Bay Batt- terminal (#2).
4. Torque to 22-39 in-lbs

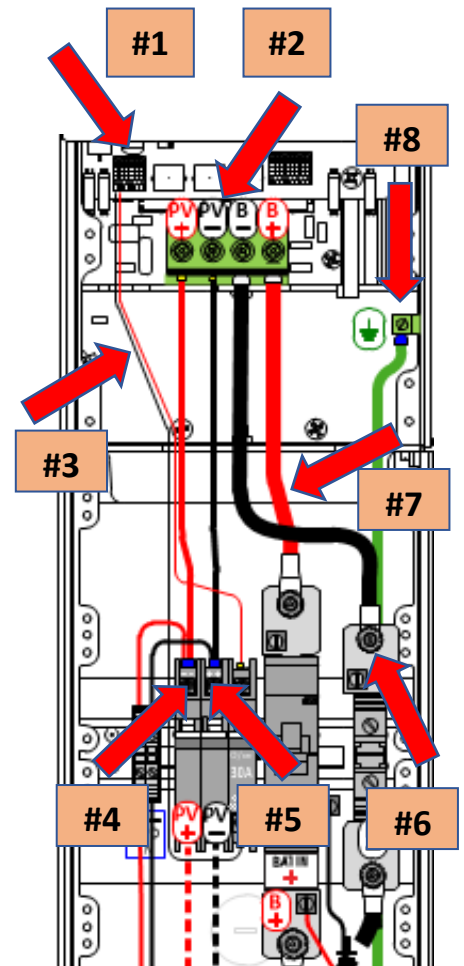

Figure 8



MNHAWKE'S BAY BB125 Manual

Ground Wire (Figure 8)

1. Ensure all breakers are off (down).
2. Insert pre-installed green ground wire into the Hawke's Bay equipment ground terminal (**Figure 8/#8**; also see **Figure 1**).
3. Torque to 35 in-lbs.

External Wiring (Figures 9 & 10)

SPD Wires (Figure 9)

4. Ensure all breakers are off (down).
5. Insert PV SPD red wire to lower left side of DIN-rail terminal block, PV+ (**#9**).
6. Insert PV SPD black wire into lower right of DIN-rail terminal block, PV- (**#9**).
7. Torque to 7.1 in-lbs.
8. Insert Battery SPD red wire to terminal lug below Batt breaker (**#10**). Torque to 19 in-lbs.
9. Insert Battery SPD black wire to terminal lug below Batt- terminal block (**#12**). Torque to 19 in-lbs.
10. Insert SPD green wires to Ground busbar (**#11**).
11. Torque to 20-30 in-lbs (small setscrew).

PV Wires (Figure 10)

1. Ensure all breakers are off (down).
2. Insert PV+ and PV- wires from the PV array into bottom of PV breaker (**#13**).
 - a. PV+ on left; PV- on right.
3. Torque to 30 in-lbs.

Batt+ Cable (Figure 10)

1. Ensure all breakers are off (down).
2. Cut sufficient length of **#2 AWG** (or larger) cable between battery bank and (**#14**).
3. Crimp **#2 AWG** terminal lugs on both ends.
 - a. Batt+ busbar requires **5/16"** (**#2 AWG x 5/16"**) lug.
4. Torque Batt+ busbar stud to 21 ft-lbs.
5. Connect terminal lug to the battery bank master positive terminal.
6. Torque per battery specs.

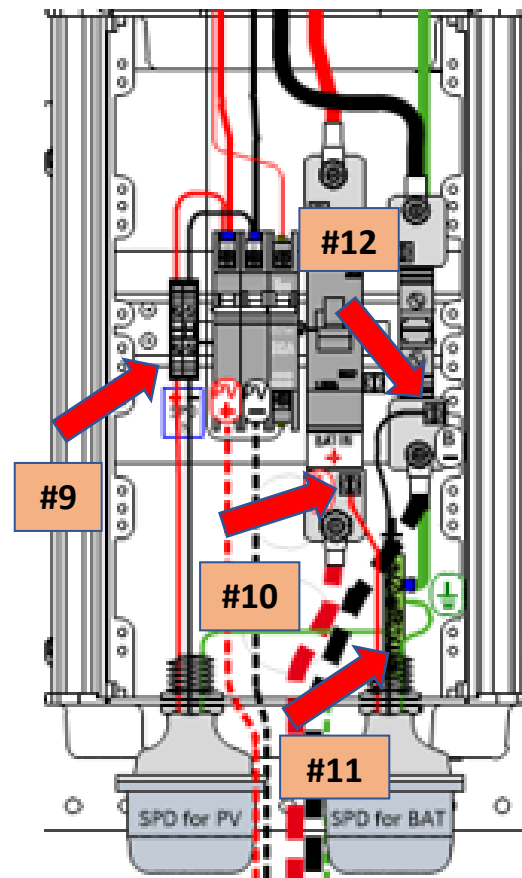

Figure 9



MNHAWKE'S BAY BB125 Manual

Batt- Cable (Figure 10)

1. Ensure all breakers are off (down).
2. Cut sufficient length of **#2 AWG** (or larger) cable between battery bank and (**#15**).
3. Crimp **#2 AWG** terminal lugs on both ends.
 - a. Batt- busbar requires **5/16"** (#2 AWG x 5/16") lug.
4. Torque Batt- busbar stud to 21 ft-lbs.
5. Connect terminal lug to the battery bank master negative terminal.
6. Torque per battery specs.

WARNING!

Verify correct polarity with a multimeter **BEFORE** connecting battery cables to Hawke's Bay.

Ground Electrode Conductor (Figure 10)

1. Ensure all breakers are off (down).
2. Cut sufficient length of **#6 AWG** ground (GEC) wire between (**#16**) and the ground rod or main ground busbar.
3. Insert ground wire (GEC) at Breaker Box Ground busbar (**#16**) and at main ground busbar or ground rod, depending on the overall grounding system design.
4. Torque to 30 in-lbs (small screws); 45 in-lbs (large screws).

The NEC or CEC may require a larger gauge Ground Electrode Conductor from (**#16**) to earth ground depending on grounding method. Check NEC/CEC.

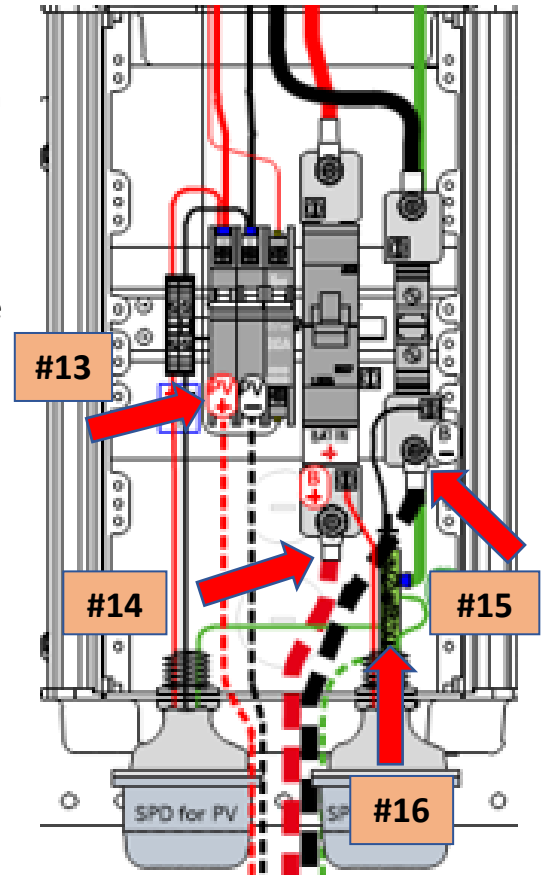

Figure 10





ENERGIZING THE HAWKE'S BAY BREAKER BOX

Read and follow the information below and the procedural steps listed by number to properly energize and test the charge controller.

Step #1 – Turn **OFF** all breakers

Step #2 – Battery

- **Voltmeter** – Measure for battery bank voltage between the Breaker Box Battery + busbar (at bottom of breaker) and the Batt- busbar.
 - Battery bank voltage present?
 - **Yes** – Good (40-65VDC).
 - **No** – Check DC wiring to the battery. Check batteries.
- Close the Batt+ breaker.
- **Voltmeter** – Measure for battery bank voltage between the Hawke's Bay Batt+ and Batt- terminals.
 - Battery bank voltage present?
 - **Yes** – Good (40-65VDC).
 - **No** – Check DC wiring or battery breaker.

Step #3 – PV

- Connect or turn on the PV/ DC input (PV combiner – ON).
- Leave the 2-Pole PV breaker off.
- **Voltmeter** – Measure for PV (open-circuit) voltage between PV+ breaker (at bottom of breaker) and PV- breaker (at bottom of breaker).
 - PV (open-circuit) voltage present?
 - **Yes** – Good (240-550VDC)
 - **No** – Check PV combiner breakers, PV wiring, or connections.
- Turn on (close) the 2P PV IN breaker.
- **Voltmeter** – Measure for PV (open-circuit) voltage between Hawke's Bay PV+ and PV- terminals.
 - PV voltage present?
 - **Yes** – Good (240-550VDC)
 - **No** – Check connections, PV IN breaker, wiring.

REVISION HISTORY

REV.	DESCRIPTION OF CHANGE	DATE	SIGN
M	DC END WAS A-1, IS 3-906-2, EXTRA CONDUIT HOLE. SCREWS HOLDING RED BRACKET TO SHORT WERE 3/8 ARE 1/2" LONG.	2/24/22	RAQ
N	ADDED BATTERY SPD BRACKETS AND ASSOCIATED HARDWARE. REPLACED OLD TR'S WITH 3-1585-1	3/2/22	RAQ
P	ADDED WIRING SHEET 4. ADDED TO DRAWING.	3/3/22	RAQ
Q	WAS FINAL. IS 13-076-1 PRE-ASSY. ADDED WIRE HARNESSES.	3/2/22	RAQ
R	ADDED 14-HB89-2 TO 8 TO PARTS LIST.	3/2/22	RAQ
G	WAS ONE HOLE PLUG. IS FOUR HOLE PLUGS 8/19/28	3/1/22	RAQ
H	REVISED DRAWINGS TO MATCH SAIGE.	3/1/22	RAQ
J	-1, ADDED 9-1407-1 PART SCREWS 9-1396-1 DC END SCREW CHANGE 6-484-1 CHASSIS SCREW CHANGE 6-484-1	11/04/22	RAQ
K	DC END SCREW CHANGE 6-484-1	11/04/22	RAQ
L	DC END SCREW CHANGE 6-484-1	11/04/22	RAQ
L	CHANGED DESCRIPTION FROM MNH8120 TO 127821 MNHAWKE'S BAY BB125	12/16/21	RAQ

PARTS LIST

QTY	PART NUMBER	DESCRIPTION
1	14-HB89-1	DC END ASSEMBLY
1	14-HB89-2	SHEET 3
1	14-HB89-3	SHEET 4
1	14-HB89-4	SHEET 5
1	14-HB89-5	SHEET 6
1	14-HB89-6	SHEET 7
1	14-HB89-7	SHEET 8
1	14-HB89-8	SHEET 9
1	3-906-2	HAWKE'S BAY-88 DC END
1	3-906-1	HAWKE'S BAY-88 CHASSIS
1	3-906-1	HAWKE'S BAY-88 TOP COVER
2	3-944-1	88-BB AND BROLIN-88 RIGHT SIDE
8	5-628-1	88-BB BROLIN-88 ROSE-88 SCREW HOLE PLUG
1	6-278-1	88-BB BROLIN-88 ROSE-88 SCREW HOLE PLUG
1	6-022-1	SCREW 10-32 X 1.50 PHF UNFINISHED 100 BLACK
3	6-065-2	SCREW 10-32 X 1.50 PHF UNFINISHED 100 BLACK
4	6-203-2	SCREW 10-32 X 1.50 PHF UNFINISHED 100 BLACK
18	6-484-1	SCREW 10-32 X 1.50 PHF UNFINISHED 100 BLACK
2	6-485-1	SCREW 10-32 X 1.50 PHF UNFINISHED 100 BLACK
1	9-1407-1	8 POSITION BUS BAR
1	9-1407-1	PLASTIC HOLE PLUG, KEYSTONE 8002-8610

ALL TOLERANCES, UNLESS OTHERWISE STATED:
X.XXX=+/-0.005"
X.XX=+/-0.01"
X.X=+/-0.05"
ALL ANGLES =+/- 1° UNLESS OTHERWISE STATED

STANDARDS:

MATERIAL:

FINISH:

PROCESS:

DATE: 6/17/2022

DESIGN CHECKED:

QA:

PIG:

APPROVED:

MDNITE SOLAR, INC.

13-076-1 MNHAWKE'S BAY-88 PRE-FINAL ASSEMBLY

DATE: 12-07-21

REV: S

FILE: 13-076-1 PRE-FINAL ASSEMBLY SHEET 1 OF 11



MNHAWKE'S BAY BB125 Manual

MIDNITE SOLAR INC. LIMITED WARRANTY

MidNite Solar Power electronics, sheet metal enclosures and accessories

MidNite Solar Inc. warrants to the original customer that its products shall be free from defects in materials and workmanship. This warranty will be valid for a period of five (5) years.

MidNite Solar will not warranty third party inverter components used in MidNite's pre-wired systems. Those components are warranted by the original manufacturer.

At its option, MidNite Solar will repair or replace at no charge any MidNite product that proves to be defective within such warranty period. This warranty shall not apply if the MidNite Solar product has been damaged by unreasonable use, accident, negligence, service, or modification by anyone other than MidNite Solar, or by any other causes unrelated to materials and workmanship. The original consumer purchaser must retain original purchase receipt for proof of purchase as a condition precedent to warranty coverage. To receive in-warranty service, the defective product must be received no later than two (2) weeks after the end of the warranty period. The product must be accompanied by proof of purchase and Return Authorization (RA) number issued by MidNite Solar. For an RMA number contact MidNite Solar Inc., (360) 403-7207. Purchasers must prepay all delivery costs or shipping charges to return any defective MidNite Solar product under this warranty policy. Except for the warranty that the products are made in accordance with, the specifications therefore supplied or agreed to by customer:

MIDNITE SOLAR MAKES NO WARRANTY EXPRESSED OR IMPLIED, AND ANY IMPLIED WARRANTY OF MERCHANTABILITY OR FITNESS FOR A PARTICULAR PURPOSE WHICH EXCEEDS THE FOREGOING WARRANTY IS HEREBY DISCLAIMED BY MIDNITE SOLAR AND EXCLUDED FROM ANY AGREEMENT MADE BY ACCEPTANCE OF ANY ORDER PURSUANT TO THIS QUOTATION. MIDNITE SOLAR WILL NOT BE LIABLE FOR ANY CONSEQUENTIAL DAMAGES, LOSS OR EXPENSE ARISING IN CONNECTION WITH THE USE OF OR THE INABILITY TO USE ITS GOODS FOR ANY PURPOSE WHATSOEVER. MIDNITE SOLAR'S MAXIMUM LIABILITY SHALL NOT IN ANY CASE EXCEED THE CONTRACT PRICE FOR THE GOODS CLAIMED TO BE DEFECTIVE OR UNSUITABLE.

Products will be considered accepted by customer unless written notice to the contrary is given to MidNite Solar within ten (10) days of such delivery to customer. MIDNITE SOLAR is not responsible for loss or damage to products owned by customer and located on MIDNITE SOLAR'S premises caused by fire or other casualties beyond MIDNITE SOLAR'S control. This warranty is in lieu of all other warranties expressed or implied.

MIDNITE SOLAR INC.

NOTICE OF COPYRIGHT

MidNite Solar's Hawke's Bay BB125 Manual.
Copyright © 2022 All rights reserved.

MidNite Solar, Inc. reserves the right to revise this document and to periodically make changes to the content hereof without obligation or organization of such revisions or changes unless required to do so by prior arrangement.



MNHAWKE'S BAY BB125 Manual

DISCLAIMER

Unless specifically agreed to in writing, MidNite Solar Inc.: (a) Makes no warranty as to the accuracy, sufficiency, or suitability of any technical or other information provided in its manuals or other documentation; (b) Assumes no responsibility or liability for loss or damage whether direct, indirect, consequential, or incidental, which might arise out of use of such information. The use of any such information will be entirely at the user's risk.

CONTACT

360.403.7207

customerservice@midnitesolar.com

www.midnitesolar.com

